

EAC-6000 USER

NVIDIA® Jetson Orin™ NX Edge AI Computing System
6 GigE LAN with 4 PoE+, 4 GMSL2, 3 USB 3.1, -25°C to 70°C Operation

Manual

Record of Revision

Version	Date	Page	Description	Remark
1.00	2024/04/01	All	Official Release	
2.00	2024/05/06	All	Updata	
3.00	2024/06/12	All	Updata	

Disclaimer

This manual is released by Vecow Co., Ltd. for reference purpose only. All product offerings and specifications are subject to change without prior notice. It does not represent commitment of Vecow Co., Ltd. Vecow shall not be liable for direct, indirect, special, incidental, or consequential damages arising out of the use of the product or documentation or any infringements upon the rights of third parties, which may result from such use.

Declaration of Conformity

FCC This equipment has been tested and found to comply with the limits for a Class A digital device, pursuant to part 15 of the FCC Rules. These limits are designed to provide reasonable protection against harmful interference when the equipment is operated in a commercial environment. This equipment generates, uses, and can radiate radio frequency energy, and if it is not installed and used in accordance with the instruction manual, it may cause harmful interference to radio communications. Operation of this equipment in a residential area is likely to cause harmful interference in which case the user will be required to correct the interference at his own expense.

CE The products described in this manual complies with all applicable European Union (CE) directives if it has a CE marking. For computer systems to remain CE compliant, only CE-compliant parts may be used. Maintaining CE compliance also requires proper cable and cabling techniques.

Copyright and Trademarks

This document contains proprietary information protected by copyright. No part of this publication may be reproduced in any form or by any means, electric, photocopying, recording or otherwise, without prior written authorization by Vecow Co., Ltd. The rights of all the brand names, product names, and trademarks belong to their respective owners.

Order Information

Part Number	Description
EAC-6000-R08-S***	EAC-6000, NVIDIA Jetson Orin NX, with On-board 8GB RAM, NVMe SSD, 2 GigE LAN, 3 USB 3.1, 2 COM, 7 GPIO, 4 M.2, 2 SIM, -25°C to 70°C
EAC-6000-R16-S***	EAC-6000, NVIDIA Jetson Orin NX, with On-board 16GB RAM, NVMe SSD, 2 GigE LAN, 3 USB 3.1, 2 COM, 7 GPIO, 4 M.2, 2 SIM, -25°C to 70°C
EAC-6100-R08-S***	EAC-6100, NVIDIA Jetson Orin NX, with On-board 8GB RAM, NVMe SSD, 2 GigE LAN, 4 GMSL2, 3 USB 3.1, 2 COM, 1 CAN, 7 GPIO, 4 M.2, 2 SIM, -25°C to 70°C
EAC-6100-R16-S***	EAC-6100, NVIDIA Jetson Orin NX, with On-board 16GB RAM, NVMe SSD, 2 GigE LAN, 4 GMSL2, 3 USB 3.1, 2 COM, 1 CAN, 7 GPIO, 4 M.2, 2 SIM, -25°C to 70°C
EAC-6200-R08-S***	EAC-6200, NVIDIA Jetson Orin NX, with On-board 8 GB RAM, NVMe SSD, 6 GigE LAN with 4 PoE+, 3 USB 3.1, 2 COM, 1 CAN, 7 GPIO, 4 M.2, 2 SIM, -25°C to 70°C
EAC-6200-R16-S***	EAC-6200, NVIDIA Jetson Orin NX, with On-board 16GB RAM, NVMe SSD, 6 GigE LAN with 4 PoE+, 3 USB 3.1, 2 COM, 1 CAN, 7 GPIO, 4 M.2, 2 SIM, -25°C to 70°C

*A NVMe SSD is included in default. Please refer to NVMe SSD List to select NVMe SSD capacity.

NVMe SSD List

Part Number	Description
S128	128GB NVMe SSD
S256	256GB NVMe SSD
S512	512GB NVMe SSD
S01T	1TB NVMe SSD

Optional Accessories

Part Number	Description
PWA-120W1	120W, 24V, 90V AC to 264V AC Power Adapter with 3-pin Terminal Block
PWA-160W-WT	160W, 24V, 85V AC to 264V AC Power Adapter with 3-pin Terminal Block, Wide Temperature -30°C to +70°C
DIN-RAIL	DIN Rail Kit
GMSL Camera Kit	GMSL Camera with Fakra-Z Connector
5G Module	5G Module with Antenna
4G Module	4G/GPS Module with Antenna
WiFi & Bluetooth	WiFi & Bluetooth Module with Antenna

Table of Contents

CHAPTER 1	GENERAL INTRODUCTION	1
1.1	Overview	1
1.2	Features	2
1.3	Product Specification	3
1.3.1	Specifications of EAC-6000	3
1.3.2	Specifications of EAC-6100	5
1.3.2	Specifications of EAC-6200	7
1.4	Mechanical Dimension	9
1.4.1	Dimensions of EAC-6000	9
1.4.2	Dimensions of EAC-6100	9
1.4.3	Dimensions of EAC-6200	10
CHAPTER 2	GETTING TO KNOW YOUR EAC-6000/EAC-6100/EAC-6200	11
2.1	Packing List	11
2.2	Front Panel I/O & Functions	12
2.3	Main Board Expansion Connectors	23
2.4	Camera Board Expansion Connectors	32
2.5	Main Board Jumper / Switch Settings	34
2.6	Ignition Control	41
CHAPTER 3	SYSTEM SETUP	43
3.1	How to Open Your EAC-6000/EAC-6100/EAC-6200	43
3.2	Installing Nano SIM Card	44
3.3	Installing Micro SD Card	45
3.4	Installing M.2	46
3.5	Installing Antenna Cable	50
3.6	Mounting Your EAC-6000/EAC-6100/EAC-6200	51

CHAPTER 4	SOFTWARE SETUP	52
4.1	Peripheral Interface Guide	52
4.2	Flash image to Your EAC-6000/6100/6200	52
4.3	Install the JetPack Package	54
4.4	Software Ignition Control	54
APPENDIX A	: Power Consumption	55
APPENDIX B	: Supported Module List	57

1

GENERAL INTRODUCTION

1.1 Overview

The Vecow EAC-6000 Series is an Arm-based Edge AI Computing System. Powered by the by NVIDIA® Jetson Orin™ NX platform, featuring a 1024-core NVIDIA Ampere™ architecture GPU with 32 Tensor cores and 8-core Arm® Cortex®-A78AE CPU, the EAC-6000 delivers best-in-class capabilities, such as up to 100 TOPS AI performance, power efficiency, and a rugged configuration. This makes it ideally suited for advanced Edge AI applications, including Medical Imaging, High-speed AOI, Mobile Robots and any AIoT/Industry 4.0 applications.

The EAC-6000 series is available in three models: EAC-6000, EAC-6100 and EAC-6200. The series is equipped with rich I/O interfaces, including 6 GigE LAN ports with 4 PoE+, 1 USB 3.1 Gen 2 port, 2 USB 3.1 ports, 2 COM RS-232/422/485 ports, 1 CAN Bus port, and 7 GPIO pins. Furthermore, the series offers seamless wireless connectivity options with 2 M.2 Key B slots, 1 M.2 Key E slot, dual SIM card sockets, and storage capabilities through the M.2 Key M PCIe x4 NVME SSD slot and Micro SD card.

With support for operating temperature from -25°C to 70°C, 9V to 50V wide range DC-in, along with GMSL1/GMSL2 automotive cameras supported by MAXIM MAX9296 via FAKRA-Z connectors, the Vecow EAC-6000 series brings small size and easy deployment of AI vision and industrial applications.

1.2 Features

- Small form factor NVIDIA® Jetson Orin™ NX supports up to 100 TOPS AI performance
- Advanced NVIDIA Ampere™ architecture with 1024 NVIDIA® CUDA® cores and 32 Tensor cores
- 6 GigE LAN with 4 PoE+, 3 USB 3.1, 2 COM RS-232/422/485
- Supports multiple 5G/4G/LTE/WiFi/BT/GPRS/UMTS connections
- Supports 4 GMSL2 automotive cameras with Fakra-Z
- 1 CAN Bus supports Flexible Data-rate, 7-bit GPIO
- DC 9V to 50V wide range power input, Ignition Power Control
- Supports 24/7 secure remote monitoring, control, and optional Out-Of-Band management for disaster recovery empowered by Allxon

1.3 Product Specification

1.3.1 Specifications of EAC-6000

System	
Processor	NVIDIA® Jetson Orin™ NX System-On-Module <ul style="list-style-type: none"> • 8-core Arm® Cortex®-A78AE v8.2 64-bit CPU • 1024 NVIDIA® CUDA® cores and 32 Tensor cores
Memory	<ul style="list-style-type: none"> • 16GB : LPDDR5 DRAM • 8GB : LPDDR5 DRAM
DL Accelerator	<ul style="list-style-type: none"> • R16 : 2x NVDLA Engine • R08 : 1x NVDLA Engine
Software Support	<ul style="list-style-type: none"> • Linux • NVIDIA JetPack SDK
Ethernet	
LAN 1 to LAN 2	10/100/1000 Base-T Ethernet GigE LAN, RJ45 Connector (Optional X-coded M12 Connector)
Graphics	
Interface	1 Digital Display : Up to 3840 x 2160 @60Hz
Video Encode	<ul style="list-style-type: none"> • HEVC : 1x 4K @60, 3x 4K @30, 6x 1080p @60, 12x 1080p @30 • H.264 : 1x 4K @60, 2x 4K @30, 5x 1080p @60, 11x 1080p @30
Video Decode	<ul style="list-style-type: none"> • HEVC : Up to 1x 8K @30, 2x 4K @60, 4x 4K @30, 9x 1080p @60 • H.264 : Up to 1x 4K @60, 2x 4K @30, 5x 1080p @60, 11x 1080p @30
I/O Interface	
USB	<ul style="list-style-type: none"> • 1 USB 3.1 Gen 2 • 2 USB 3.1
Serial	2 COM RS-232/422/485
CAN Bus	1 CAN Bus supports CAN FD
GPIO	7-bit GPIO
Button	<ul style="list-style-type: none"> • 1 Power Button • 1 Force Recovery Button • 1 Reset Button
Micro USB	<ul style="list-style-type: none"> • 1 Micro USB Console Port • 1 Micro USB Recovery Port
SIM	2 SIM Card Socket
LED	Power, SSD
Antenna	6 Antenna for WiFi/4G/5G/LTE/GPRS/UMTS

Expansion	
M.2	<ul style="list-style-type: none"> • 2 M.2 Key B Socket (3042/3052, USB3) • 1 M.2 Key E Socket (2230, PCIe/USB)
Storage	
SD	1 Micro SD (External)
M.2	1 M.2 Key M 2280, up to 1TB NVMe SSD pre-installed
Power	
Power Input	DC 9V to 50V
Power Interface	3-pin Terminal Block : V+, V-, Frame Ground
Ignition Control	16-mode Software Ignition Control
Remote Switch	3-pin Remote Switch Terminal Block
Mechanical	
Dimensions	193 mm x 134 mm x 55 mm (7.6" x 5.28" x 2.17")
Weight	1.7 kg (3.74 lb)
Mounting	<ul style="list-style-type: none"> • Wallmount • DIN Rail (Optional)
Environment	
Operating Temperature	15W TDP Mode : -25°C to 70°C (-13°F to 158°F) 25W TDP Mode : -25°C to 55°C (-13°F to 131°F)
Storage Temperature	-40°C to 85°C (-40°F to 185°F)
Humidity	5% to 95% Humidity, non-condensing
Relative Humidity	95% @ 70°C
Shock	Operating, MIL-STD-810H, Method 516.8, Procedure I
Vibration	Operating, MIL-STD-810G, Method 514.6, Procedure I, Category 4
EMC	CE, FCC, EN50155, EN50121-3-2

1.3.2 Specifications of EAC-6100

System	
Processor	NVIDIA® Jetson Orin™ NX System-On-Module <ul style="list-style-type: none"> • 8-core Arm® Cortex®-A78AE v8.2 64-bit CPU • 1024 NVIDIA® CUDA® cores and 32 Tensor cores
Memory	<ul style="list-style-type: none"> • 16GB : LPDDR5 DRAM • 8GB : LPDDR5 DRAM
DL Accelerator	<ul style="list-style-type: none"> • R16 : 2x NVDLA Engine • R08 : 1x NVDLA Engine
Software Support	<ul style="list-style-type: none"> • Linux • NVIDIA JetPack SDK
Ethernet	
LAN 1 to LAN 2	10/100/1000 Base-T Ethernet GigE LAN, RJ45 Connector (Optional X-coded M12 Connector)
Graphics	
Interface	1 Digital Display : Up to 3840 x 2160 @60Hz
Video Encode	<ul style="list-style-type: none"> • HEVC : 1x 4K @60, 3x 4K @30, 6x 1080p @60, 12x 1080p @30 • H.264 : 1x 4K @60, 2x 4K @30, 5x 1080p @60, 11x 1080p @30
Video Decode	<ul style="list-style-type: none"> • HEVC : Up to 1x 8K @30, 2x 4K @60, 4x 4K @30, 9x 1080p @60 • H.264 : Up to 1x 4K @60, 2x 4K @30, 5x 1080p @60, 11x 1080p @30
Camera	
GMSL	4 Fakra-Z connectors for GMSL 1/2 automotive cameras
I/O Interface	
USB	<ul style="list-style-type: none"> • 1 USB 3.1 Gen 2 • 2 USB 3.1
Serial	2 COM RS-232/422/485
CAN Bus	1 CAN Bus supports CAN FD
GPIO	7-bit GPIO
Button	<ul style="list-style-type: none"> • 1 Power Button • 1 Force Recovery Button • 1 Reset Button
Micro USB	<ul style="list-style-type: none"> • 1 Micro USB Console Port • 1 Micro USB Recovery Port
SIM	2 SIM Card Socket
LED	Power, SSD
Antenna	10 Antenna for WiFi/4G/5G/LTE/GPRS/UMTS

Expansion	
M.2	<ul style="list-style-type: none"> • 2 M.2 Key B Socket (3042/3052, USB3) • 1 M.2 Key E Socket (2230, PCIe/USB)
Storage	
SD	1 Micro SD (External)
M.2	1 M.2 Key M 2280, up to 1TB NVMe SSD pre-installed
Power	
Power Input	DC 9V to 50V
Power Interface	3-pin Terminal Block : V+, V-, Frame Ground
Ignition Control	16-mode Software Ignition Control
Remote Switch	3-pin Remote Switch Terminal Block
Mechanical	
Dimensions	193 mm x 134 mm x 80 mm (7.6" x 5.28" x 3.15")
Weight	1.9 kg (4.19 lb)
Mounting	<ul style="list-style-type: none"> • Wallmount • DIN Rail (Optional)
Environment	
Operating Temperature	15W TDP Mode : -25°C to 70°C (-13°F to 158°F) 25W TDP Mode : -25°C to 55°C (-13°F to 131°F)
Storage Temperature	-40°C to 85°C (-40°F to 185°F)
Humidity	5% to 95% Humidity, non-condensing
Relative Humidity	95% @ 70°C
Shock	Operating, MIL-STD-810H, Method 516.8, Procedure I
Vibration	Operating, MIL-STD-810G, Method 514.6, Procedure I, Category 4
EMC	CE, FCC, EN50155, EN50121-3-2

1.3.2 Specifications of EAC-6200

System	
Processor	NVIDIA® Jetson Orin™ NX System-On-Module <ul style="list-style-type: none"> • 8-core Arm® Cortex®-A78AE v8.2 64-bit CPU • 1024 NVIDIA® CUDA® cores and 32 Tensor cores
Memory	<ul style="list-style-type: none"> • 16GB : LPDDR5 DRAM • 8GB : LPDDR5 DRAM
DL Accelerator	<ul style="list-style-type: none"> • R16 : 2x NVDLA Engine • R08 : 1x NVDLA Engine
Software Support	<ul style="list-style-type: none"> • Linux • NVIDIA JetPack SDK
Ethernet	
LAN 1 to LAN 2	10/100/1000 Base-T Ethernet GigE LAN, RJ45 Connector (Optional X-coded M12 Connector)
PoE	
LAN 3 to LAN 6	IEEE 802.3at (25.5W/48V) GigE PoE+ LAN, RJ45 Connector (Optional X-coded M12 Connector)
Graphics	
Interface	1 Digital Display : Up to 3840 x 2160 @60Hz
Video Encode	<ul style="list-style-type: none"> • HEVC : 1x 4K @60, 3x 4K @30, 6x 1080p @60, 12x 1080p @30 • H.264 : 1x 4K @60, 2x 4K @30, 5x 1080p @60, 11x 1080p @30
Video Decode	<ul style="list-style-type: none"> • HEVC : Up to 1x 8K @30, 2x 4K @60, 4x 4K @30, 9x 1080p @60 • H.264 : Up to 1x 4K @60, 2x 4K @30, 5x 1080p @60, 11x 1080p @30
Camera	
GMSL	4 Fakra-Z connectors for GMSL 1/2 automotive cameras
I/O Interface	
USB	<ul style="list-style-type: none"> • 1 USB 3.1 Gen 2 • 2 USB 3.1
Serial	2 COM RS-232/422/485
CAN Bus	1 CAN Bus supports CAN FD
GPIO	7-bit GPIO
Button	<ul style="list-style-type: none"> • 1 Power Button • 1 Force Recovery Button • 1 Reset Button
Micro USB	<ul style="list-style-type: none"> • 1 Micro USB Console Port • 1 Micro USB Recovery Port
SIM	2 SIM Card Socket

LED	Power, SSD
Antenna	10 Antenna for WiFi/4G/5G/LTE/GPRS/UMTS
Expansion	
M.2	<ul style="list-style-type: none"> • 2 M.2 Key B Socket (3042/3052, USB3) • 1 M.2 Key E Socket (2230, PCIe/USB)
Storage	
SD	1 Micro SD (External)
M.2	1 M.2 Key M 2280, up to 1TB NVMe SSD pre-installed
Power	
Power Input	DC 9V to 50V
Power Interface	3-pin Terminal Block : V+, V-, Frame Ground
Ignition Control	16-mode Software Ignition Control
Remote Switch	3-pin Remote Switch Terminal Block
Mechanical	
Dimensions	193 mm x 134 mm x 80 mm (7.6" x 5.28" x 3.15")
Weight	1.9 kg (4.19 lb)
Mounting	<ul style="list-style-type: none"> • Wallmount • DIN Rail (Optional)
Environment	
Operating Temperature	15W TDP Mode : -25°C to 70°C (-13°F to 158°F) 25W TDP Mode : -25°C to 55°C (-13°F to 131°F)
Storage Temperature	-40°C to 85°C (-40°F to 185°F)
Humidity	5% to 95% Humidity, non-condensing
Relative Humidity	95% @ 70°C
Shock	Operating, MIL-STD-810H, Method 516.8, Procedure I
Vibration	Operating, MIL-STD-810G, Method 514.6, Procedure I, Category 4
EMC	CE, FCC, EN50155, EN50121-3-2

1.4 Mechanical Dimension

1.4.1 Dimensions of EAC-6000

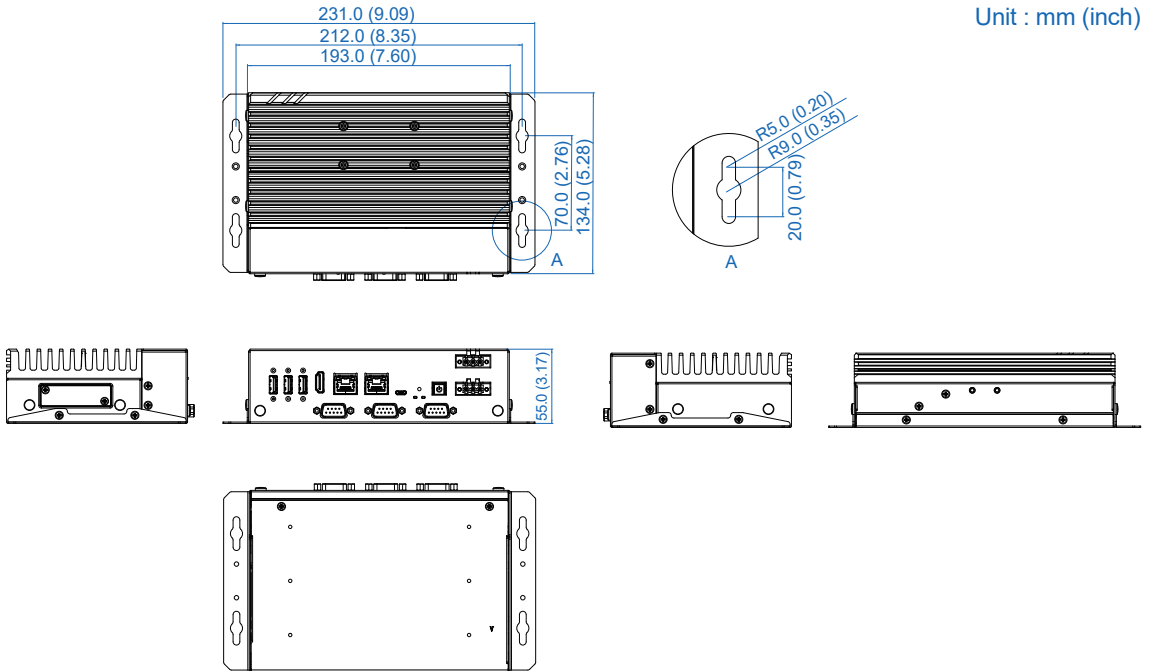

1.4.2 Dimensions of EAC-6100

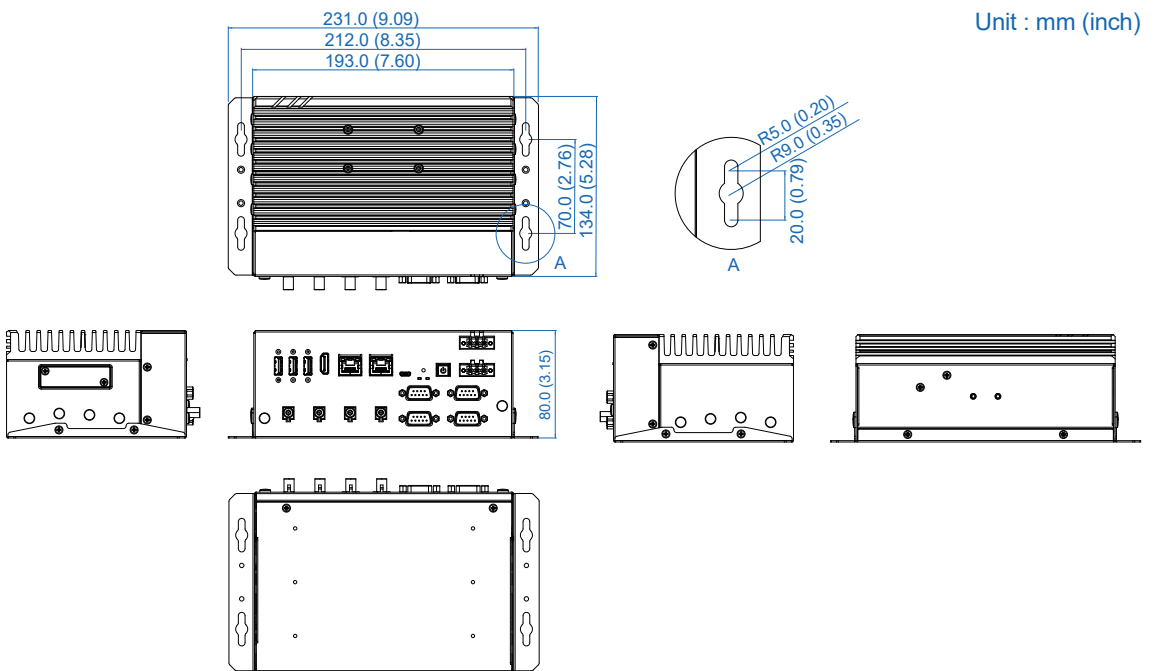

1.4.3 Dimensions of EAC-6200

Unit : mm (inch)

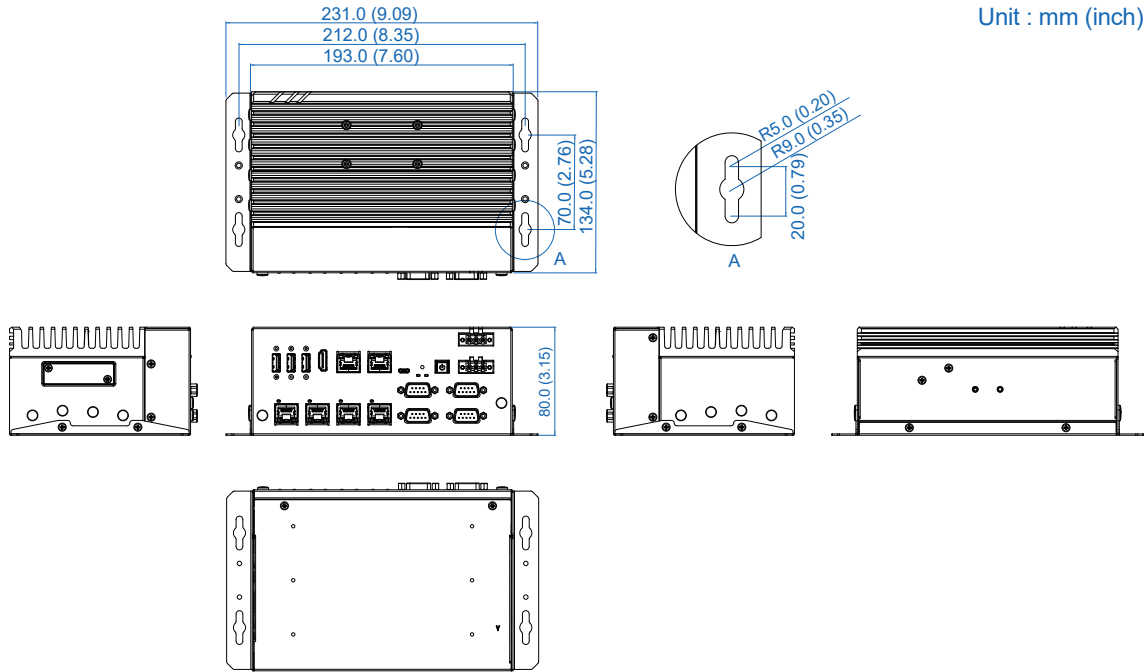





2

GETTING TO KNOW YOUR EAC-6000/EAC-6100/EAC-6200

2.1 Packing List

Item	Description	Qty
1	EAC-6000/EAC-6100/EAC-6200 Edge AI Computing System (According to the configuration of your order, EAC-6000/ EAC-6100/ EAC-6200 series may contain micro SD and M.2 modules. Please verify these items if necessary.)	1

Item	Description	Outlook	Usage	P/N	Qty
1	Terminal block 3-pin (5.0mm)		DC-IN	51-2411R03-S1B	2
2	PHILLPIS M3x4L, Ni+Ny		M.2 socket	53-2426204-80B	6
3	Flat head_ M3x4L_ Ni_Nylok		Fasten wall mount bracket to EAC-6000	53-M006350-010	4
4	Wall mount EAC-6000		Wall mount bracket	62-13P1661-0EA	2
5	Transfer Bracket		M.2 B-KEY	62-01P0973-00B	2

2.2 Front Panel I/O & Functions

2.2.1 Functions of EAC-6000 series

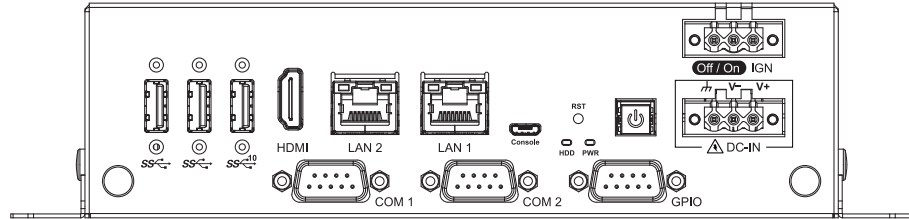

In Vecow EAC-6000 series, Most of the I/O connectors are located on the front panels. Most of the general connections to computer devices, such as POWER CON, IGN CON, COM, USB 3.0, LAN (RJ-45), Digital Display Port, GPIO, POWER BUTTON, RESET BUTTON, LED indicators are placed on the front panel.

2.2.1.1 Power Terminal Block

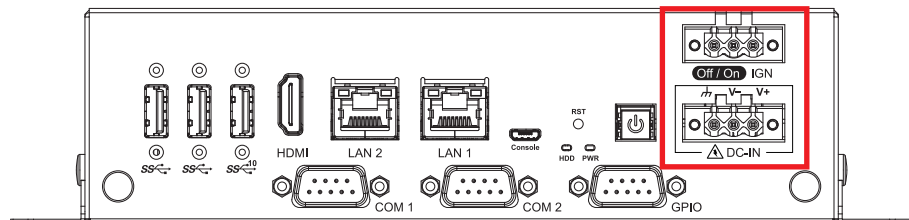

EAC-6000 supports 9V to 50V DC wide range power input by terminal block. It can be divided into Top layer and Bottom layer. The Top layer is Ignition signal control application, and the bottom layer is power source input.

Pin No.	Function
1	V+
2	V-
3	Chassis Ground
4	Ignition
5	PWR BTN
6	GND

2.2.1.2 Power Button

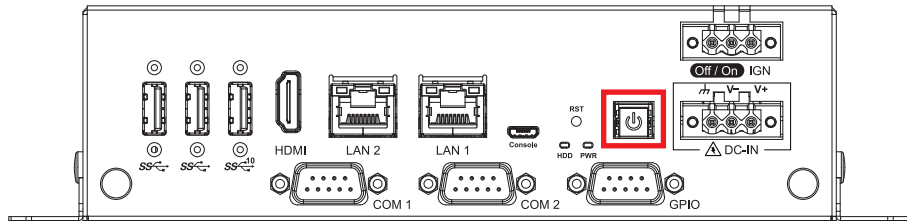

The Power Button is a non-latched switch with dual color LED indication.

To power on the system, press the power button and then the Blue LED is lightened. To power off the system, the Orange LED of power button is lightened, you can either command shutdown by OS operation, or just simply press the power button.

2.2.1.3 Reset Button

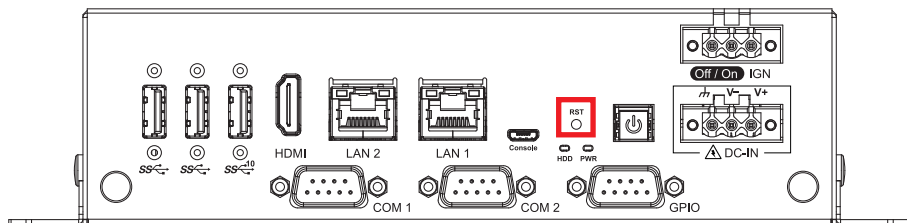

If the system have error or frozen status, you can press Reset Button to restart, then the system will reboot OS.

2.2.1.4 Ethernet Port

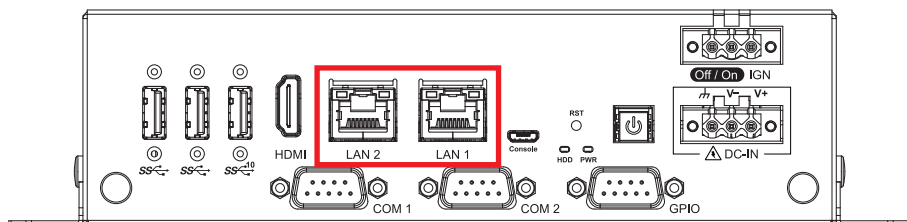

There are two 8-pin RJ-45 jacks supporting 10/100/1000 Mbps Ethernet connections on the front side of EAC-6000 series. It supports 1000BASE-T gigabit data signals over standard Ethernet Cat 5/Cat 6 cable.

LAN Chip	Function	Connector
RTL8211_LAN1	RJ-45(10/100/1000)	LAN1
I210_LAN2	RJ-45(10/100/1000)	LAN2

Using suitable RJ-45 cable, you can connect the system to a computer, or to any other devices with Ethernet connection, for example, a hub or a switch. The pin-outs of LAN1 and LAN2 are listed as follows:

Pin No.	10/100Mbps	1000Mbps
1	E_TX+	MDI0_P
2	E_TX-	MDI0_N
3	E_RX+	MDI1_P
4	-----	MDI2_P
5	-----	MDI2_N
6	E_RX-	MDI1_N
7	-----	MDI3_P
8	-----	MDI3_N

Each LAN port is supported by standard RJ-45 connector with LED indicators to present Active/ Link/ Speed status of the connection .

LED Location	LED Color	10Mbps	100Mbps	1000Mbps
Right	Green	Off	Solid Green	Solid Orange
Left	Yellow	Twinkling Yellow	Twinkling Yellow	Twinkling Yellow

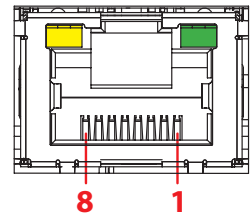

2.2.1.5 USB 3.2 Gen2

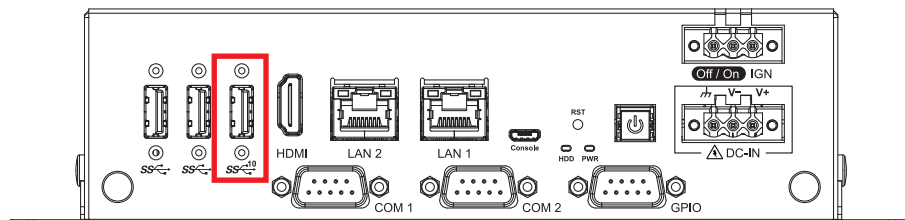

There is a USB 3.2 Connector connections available supporting up to 10Gb per second data rate in the front side of EAC-6000 series. It also compliant with the requirements of Super Speed (SS), high speed (HS), full speed (FS) and low speed (LS).

2.2.1.6 USB 3.2 Gen1

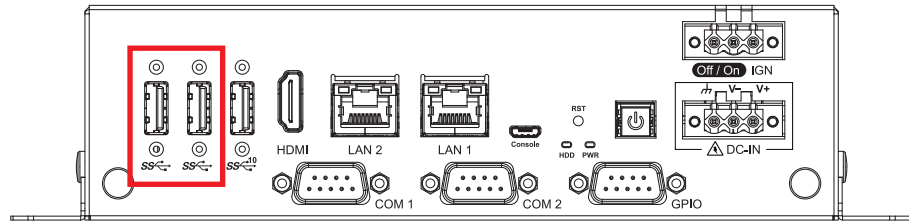

There are 2 USB 3.2 Gen1 Connector connections available supporting up to 5Gb per second data rate in the front panel of EAC-6000 series. It is also compliant with the requirements of Speed (SS), High Speed (HS), Full Speed (FS) and Low Speed (LS).

2.2.1.7 Digital Display Port

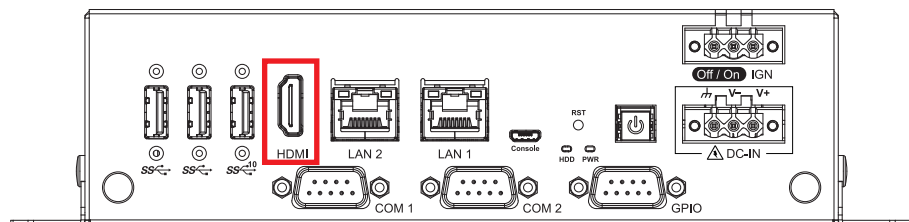

The Digital Display Port(HDMI) support HDMI V2.0 interface, connection supports up to Up to 3840 x 2160 @60Hz.

2.2.1.8 COM Port

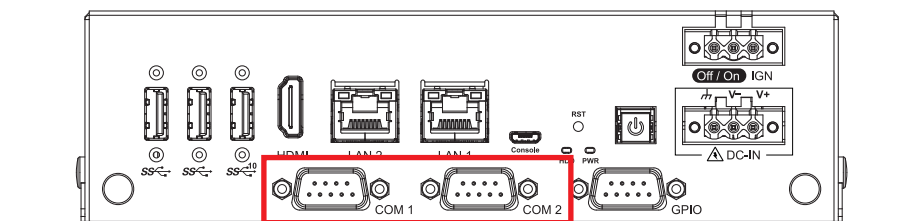

The COM 1,2 can be configured for RS-232, RS-422, or RS-485 with auto flow control communication. The default definition of COM 1 and COM2 is RS-232; if you want to use RS-422 or RS-485, you have to change COM mode the DIP Switch mode select.

The rear D-SUB connector pin assignments are listed in the following table :

Serial Port	Pin No.	RS-232	RS-422 (5-wire)	RS-485 (3-wire)
COM1 COM2	1	-----	TXD-	DATA-
	2	RXD	TXD+	DATA+
	3	TXD	RXD+	-----
	4	-----	RXD-	-----
	5	GND	GND	GND
	6	-----	-----	-----
	7	RTS	-----	-----
	8	CTS	-----	-----
	9	-----	-----	-----

2.2.1.9 Console Port

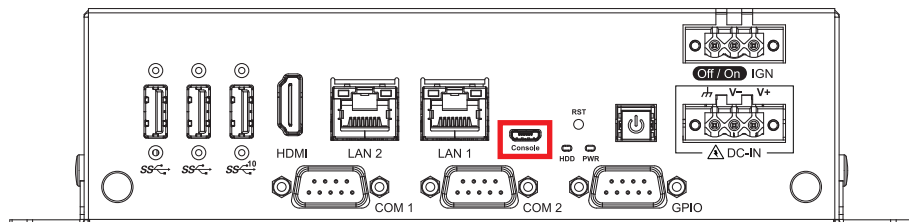

The Console Port is debug Port of system, it connected by Micro USB connector. It can be connected by USB (Type A to Micro USB Type) Cable to USB Port of PC, and execute terminal tool, then it will get the system status message.

Pin No.	Function
1	+V5
2	USB_DATA-
3	USB_DATA+
4	NC
5	GND

2.2.1.10 HDD & Status LED Indicators

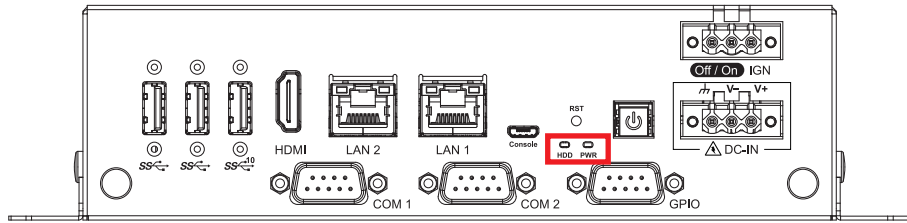

The HDD LED is presented with the storage active status. The PWR LED is presented with power of system is ready.on.normally.

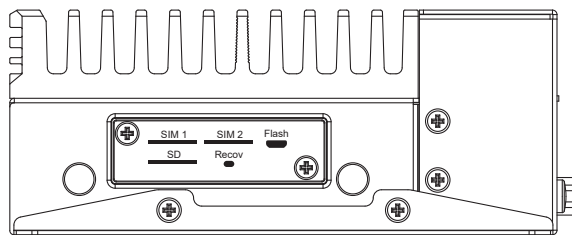

There are some ports SIM1, SIM2, Flash, M-SD Card and Recovery Button are placed on the side panel. It has a case cover these ports.

2.2.1.11 Flash Port

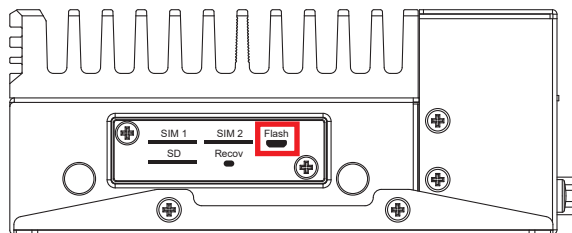

The EAC-6000 USB Recovery mode provides an alternate boot device (USB). In this mode, the system is connected to a host system and boots over USB. This is used when a new image needs to be flashed. USB0 must be available to use as USB Device for USB Recovery Mode.

Pin No.	Function
1	VBUS_DET
2	USB_DATA-
3	USB_DATA+
4	NC
5	GND

2.2.1.12 Force_Recovery Button

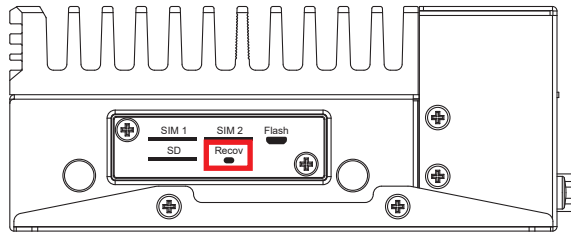

Press the Button enter Force Recovery Mode. Button is held down while either system is first powered on, or by pressing & releasing reset button while Recovery button is pressed.

2.2.1.13 Micro SD

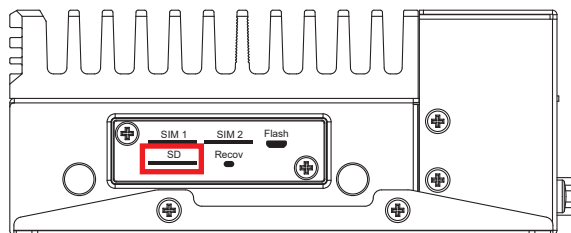

The external Micro SD card provides additional storage expansion. It is located behind the cover-plate on the front panel.

2.2.1.14 Nano SIM

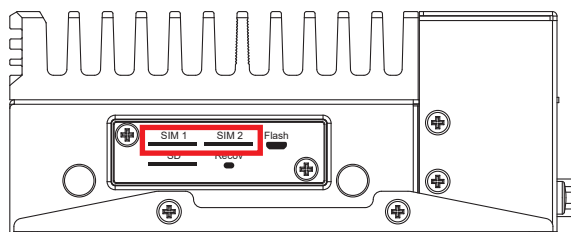

The external Nano SIM card offers wireless communication capability by M.2 key B 4G/5G Card to the system.

2.2.1.15 GPIO

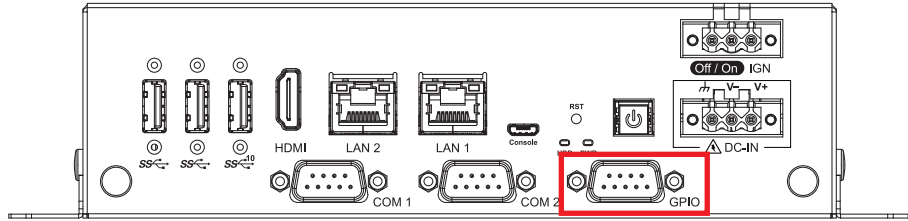

The power voltage of each GPIO pin is 0V to 3.3V. The maximum current can be 100mA.

GPIO Connector Pin Out:

Pin No.	Function
1	RSV_GPIO_P00
2	RSV_GPIO_P01
3	RSV_GPIO_P02
4	RSV_GPIO_P03
5	RSV_GPIO_P04
6	RSV_GPIO_P05
7	RSV_GPIO_P06
8	GND
9	X

2.2.2 Functions of EAC-6100

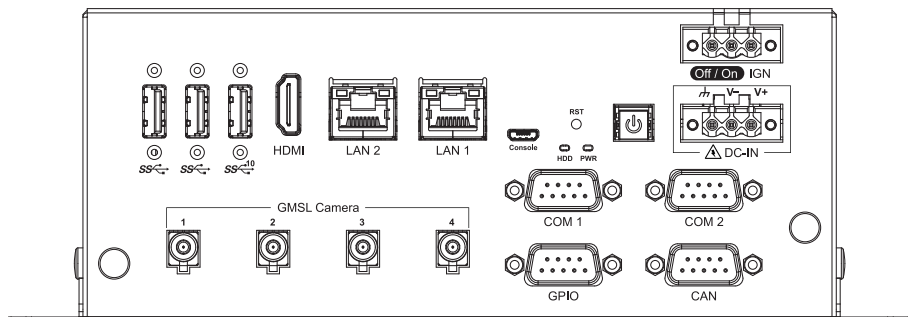

2.2.2.1 GMSL Camera Port

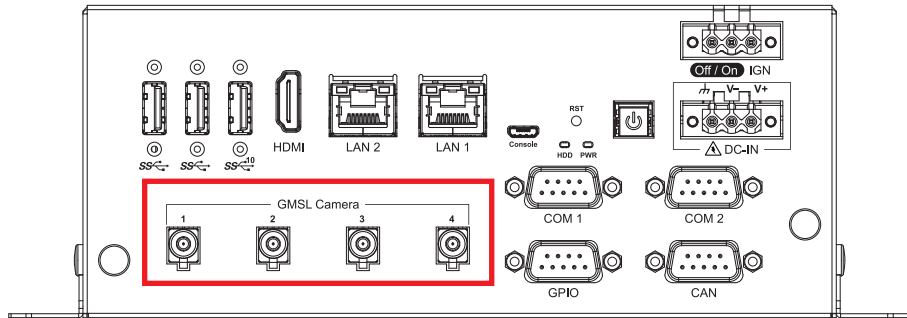

There are four FAKRA connectors in the front side of EAC-6100. Each camera connects to the EAC-6100 through a single coax cable. Using GMSL2 (Gigabit Multimedia Serial Link) connections, the cameras are connected to a two-port deserializer. The output of the deserializer is MIPI CSI-2.

2.2.2.2 CAN Port

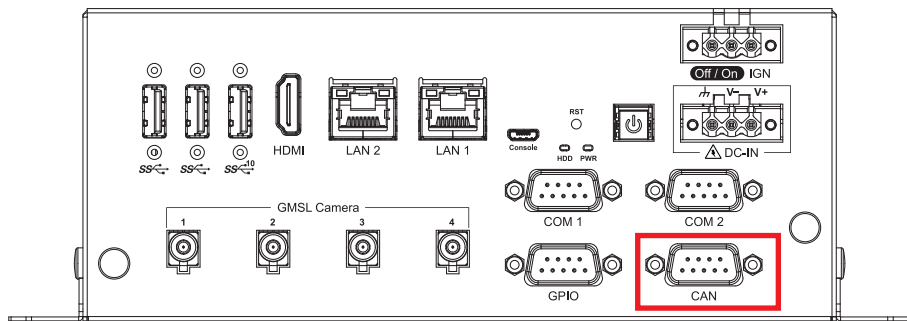

CAN Bus Connector Pin Out:

Pin No.	Function
1	CANH1
2	CANL1
3	GND
4	X
5	X
6	X
7	X
8	X
9	X

2.2.3 Functions of EAC-6200

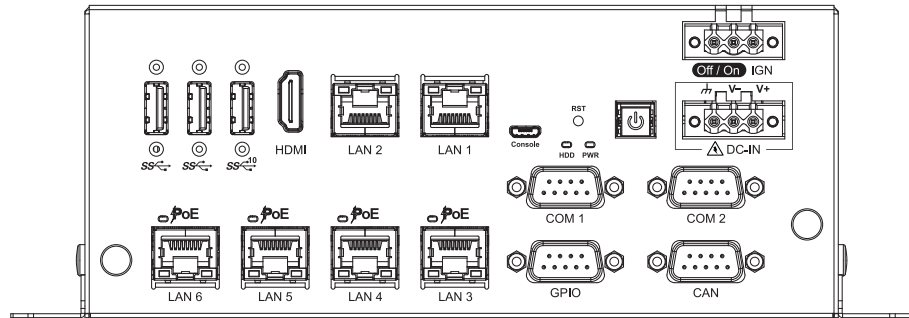

2.2.3.1 LAN3 – LAN6: PoE Port

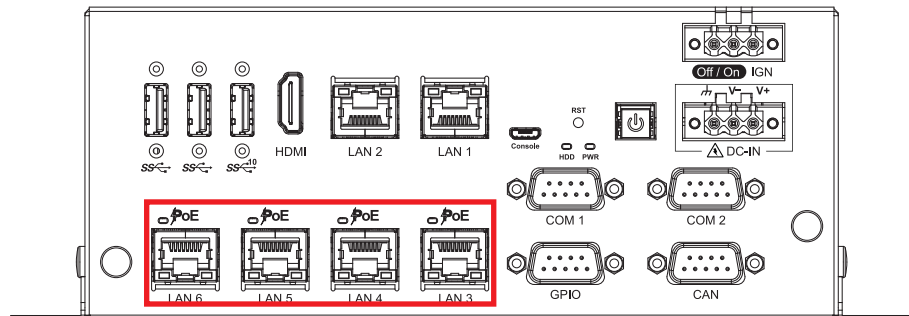

There are 4 RJ45 connectors in the front side of EAC-6200. It supports IEEE802.3at (PoE+) Power over Ethernet (PoE) connection delivering up to 25W/54V per port and 1000BASE-T gigabit data signals over standard Ethernet Cat 5/Cat6 cable.

Each PoE connection is powered by Intel® I350 Gigabit Ethernet controller and independent PCI express interface to connect with multi-core processor for network and data transmit optimization. Only when PoE port starts to supply power to power devices, the dedicated LED will be lightened.

PS. Suggest to use PoE function when power input is over 24V.

The pin-outs of LAN3 – LAN6 are listed as follows:

Pin No.	10/100 Mbps	1000Mbps	PoE
1	E_TX+	MDI0_P	PoE+
2	E_TX-	MDI0_N	PoE+
3	E_RX+	MDI1_P	PoE-
4	----	MDI2_P	----
5	----	MDI2_N	----
6	E_RX-	MDI1_N	PoE-
7	----	MDI3_P	----
8	-----	MDI3_N	----

2.2.3.2 CAN Port

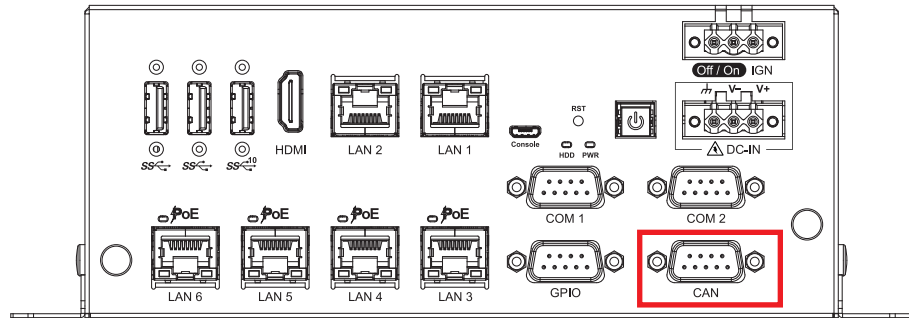

CAN Bus Connector Pin Out:

Pin No.	Function
1	CANH1
2	CANL1
3	GND
4	X
5	X
6	X
7	X
8	X
9	X

2.3 Main Board Expansion Connectors

2.3.1 TOP View of MB

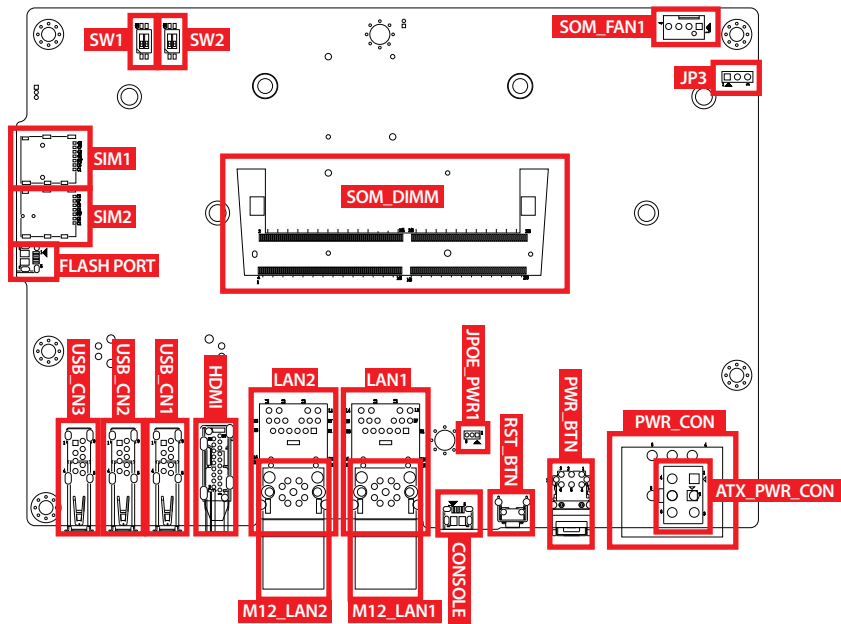

BOT View of MB

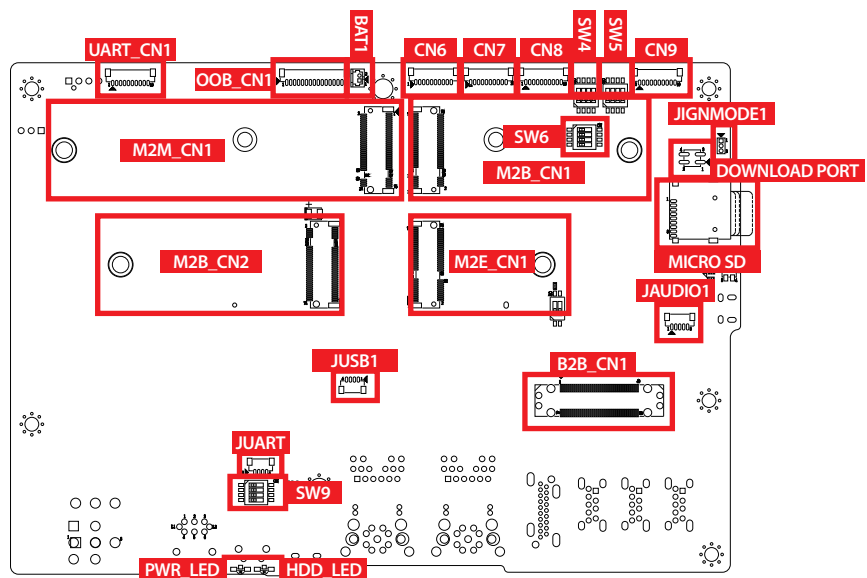

2.3.1.1 B2B_CN1 Board to Board Connector

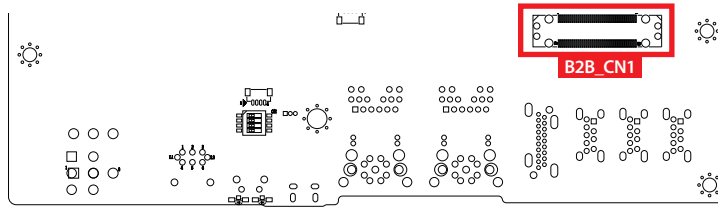

B2B_CN1 connector apply to EAC-6000-CB and EAC-6000-PE board use. Host I/Fs supported MIPI CSI x4 transfer GMSLx4 with Fakra Connector and PCIe x1 transfer 4 GigE with PoE LAN.

No.	Definition	No.	Definition	No.	Definition	No.	Definition
1	PWR 12V	21	CSI1_D0_P	41	GND	61	CSI0_CLK_N
2	PWR 12V	22	CSI1_D0_N	42	CAM1_MCLK	62	GND
3	PWR 12V	23	GND	43	CAM1_PWDN	63	CSI0_D0_P
4	PWR 12V	24	GND	44	GND	64	CSI0_D0_N
5	PWR 12V	25	GND	45	CSI2_D1_P	65	GND
6	PWR 12V	26	I2C0_SCL	46	CSI2_D1_N	66	PCIE3_TX0_P
7	GND	27	I2C0_SDA	47	GND	67	PCIE3_TX0_N
8	CSI3_D1_P	28	GND	48	CSI2_CLK_P	68	GND
9	CSI3_D1_N	29	PWR 3.3V	49	CSI2_CLK_N	69	PCIE3_RX0_P
10	GND	30	PWR 3.3V	50	GND	70	PCIE3_RX0_N
11	CSI3_D0_P	31	PWR 3.3V	51	CSI2_D0_P	71	GND
12	CSI3_D0_N	32	PWR 3.3V	52	CSI2_D0_N	72	PCIE3_CLK_P
13	GND	33	PWR 3.3V	53	GND	73	PCIE3_CLK_N
14	CAM_I2C_SCL	34	GND	54	CAM0_MCLK	74	GND
15	CAM_I2C_SDA	35	PWR 5V	55	CAM0_PWDN	75	PCIE3_RST
16	CAM_GPIO	36	PWR 5V	56	GND	76	GND
17	GND	37	PWR 5V	57	CSI0_D1_P	77	PWR 5V
18	CSI1_D1_P	38	PWR 5V	58	CSI0_D1_N	78	PWR 5V
19	CSI1_D1_N	39	PWR 5V	59	GND	79	PWR 5V
20	GND	40	PWR 5V	60	CSI0_CLK_P	80	PWR 5V

2.3.1.2 Fan Connector (SOM_FAN1)

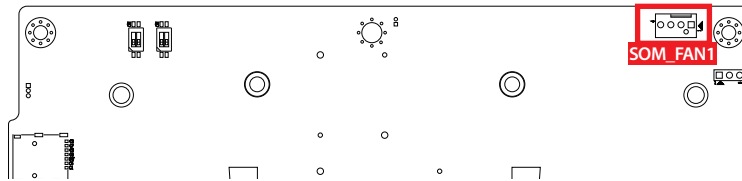

Pin assignment as the following table :

	Pin No.	Description
	1	GND
	2	+12V(1A max)
	3	Fan Speed Sensor
	4	Fan PWM

2.3.1.3 CN8 / CN9 : COM Serial Port

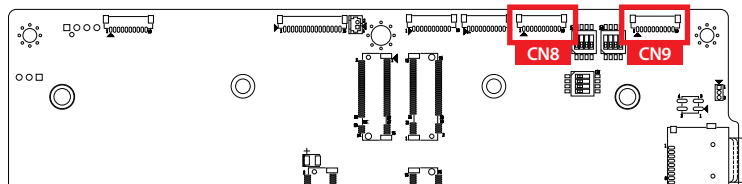

Serial port COM2/ COM1 (CN8/CN9) can be configured for RS-232, RS-422, or RS-485 with auto flow control communication. The default definition of COM 1 ,2 is RS-232, if you want to change to RS-422 or RS-485, it must change COM mode by DIP SW (COM1 SW5, COM2 SW4).

	Pin No.	Description
	1	NC
	2	GND
	3	NC
	4	COM_DTR
	5	COM_CTS
	6	COM_TXD
	7	COM_RTS
	8	COM_RXD
	9	NC
	10	COM_DCD

2.3.1.4 CN7 : Reserve GPIO

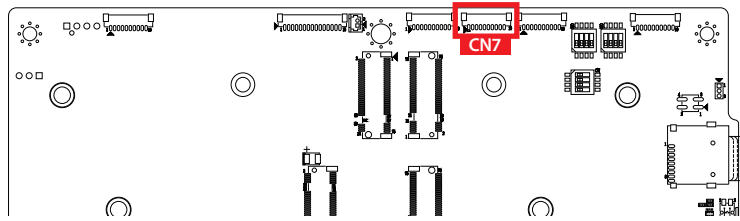

The connector include 7 bit GPIO with 3.3 power level, it can be set GPI or GPO mode what you want.

	Pin No.	Definition
	1	PWR 5V
	2	PWR 3.3V
	3	GPIO0
	4	GPIO1
	5	GPIO2
	6	GPIO3
	7	GPIO4
	8	GPIO5
	9	GPIO6
	10	GND

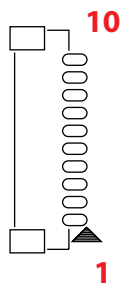

2.3.1.5 CN6: Reserve I2C/SPI

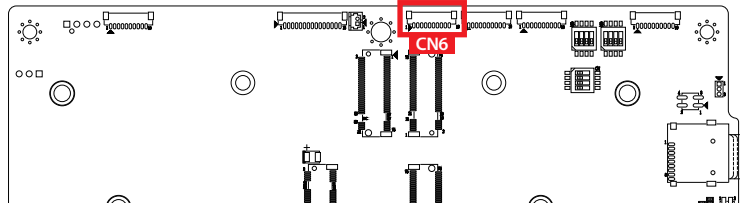

The connector include I2C and SPI bus for reserve application.

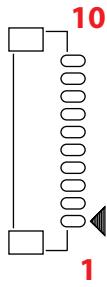
	Pin No.	Definition
	1	PWR 5V
	2	PWR 3.3V
	3	I2C1_SCL
	4	I2C1_SDA
	5	GND
	6	SPI1_SCK
	7	SPI1_MISO
	8	SPI1_MOSI
	9	SPI1_CS0
	10	GND

2.3.1.6 BAT1: RTC Battery

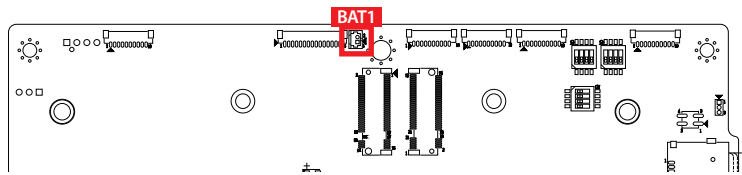

The BAT1 connector is connected by CR2032 with cable supply power for RTC IC, if the battery is disconnected, the RTC function will not be work, and it will have a wrong time of OS.

	Pin No.	Definition
	1	P3.3V
	2	GND

2.3.1.7 OOB_CN1: OOB

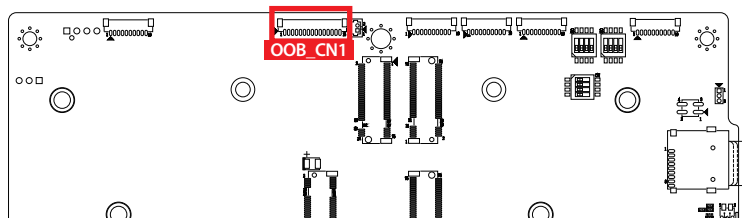

The connector is connected by OOB daughter board, if you want to remote control the system function (Power on / reset or monitor).

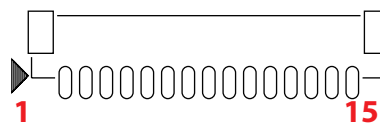

No.	Definition	No.	Definition	No.	Definition
1	PWR 5V	6	GND	11	OOB_SDA
2	PWR 5V	7	OOB_RXD	12	GND
3	GND	8	OOB_TXD	13	PSW_NU
4	GPIO0	9	GND	14	RST_SW
5	GPIO1	10	OOB_SCL	15	PWR_DET

2.3.1.8 CN10 : UART / CAN BUS

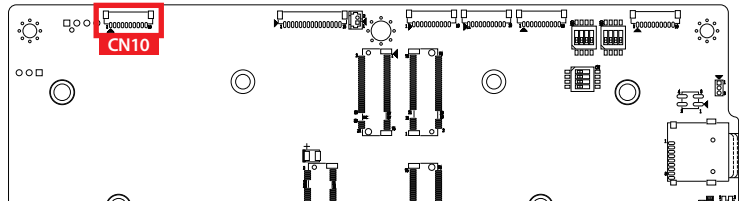

The Connector is suitable for combo applications that use Host I/Fs supported CAN BUS and UART (COM2). It must be switched by DIP SWITCH SW8 (2.4.1.7) if the UART signal is enabled.

	Pin No.	Definition
	1	PWR 5V
	2	UART_TXD
	3	UART_RXD
	4	UART_RTS
	5	UART_CTS
	6	GND
	7	GND
	8	CAN_H
	9	CAN_L
	10	GND

2.3.1.9 M2M_CN1 : M.2 Key M Slot

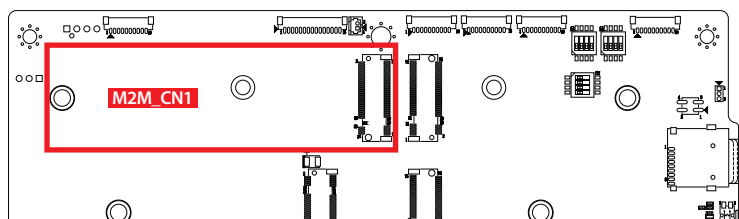

The M.2 key M connector is suitable for applications that use Host I/Fs supported PCIe Gen 4 x4, it can be plugged NvME Module card 2280 type.

2.3.1.10 M2B_CN1 : M.2 key B Slot

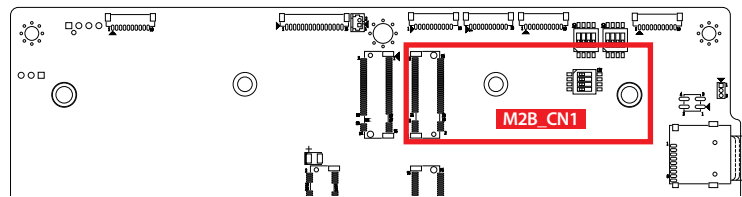

The M.2 key B connector is suitable for applications that use Host I/Fs supported USB 3.0, USB 2.0, it can be plugged including LTE/5G, NvME Module card 3052 type.

2.3.1.11 M2B_CN2 : M.2 key B Slot

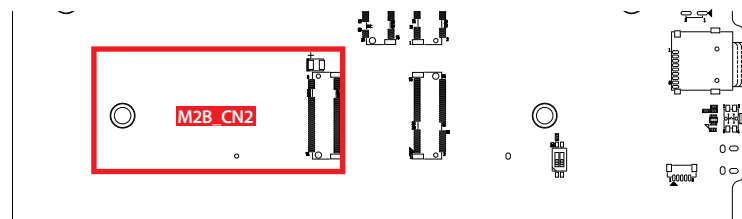

The M.2 key B connector is suitable for applications that use Host I/Fs supported USB 3.0, USB 2.0, it can be plugged including LTE/5G, NvME Module card 3052 type.

2.3.1.12 M2E_CN1 : M.2 key E Slot

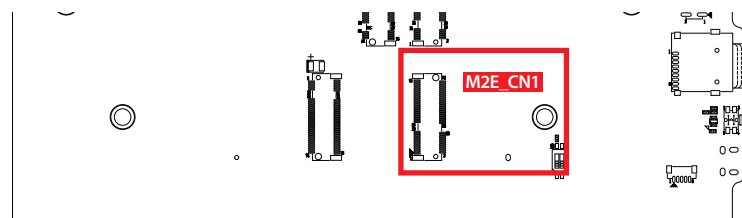

The M.2 key E connector is suitable for applications that use wireless connectivity including Wi-Fi, Bluetooth, NFC or GNSS. Module card types include 2230.

2.3.1.13 JAUDIO01 : Line-out / Mic In Connector

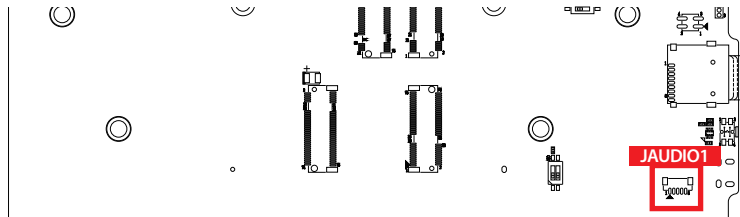

The Connector is connected by Audio Jack Cable for Line-out and Mic In application. It must be switched by DIP SWITCH SW8 (2.4.1.7) if the Audio signal is enabled.

	Pin No.	Definition
	1	AUDIO_L
	2	AUDIO_R
	3	GND
	4	MIC_L
	5	MIC_R

2.3.1.14 JUSB1 : Reserve USB Connector

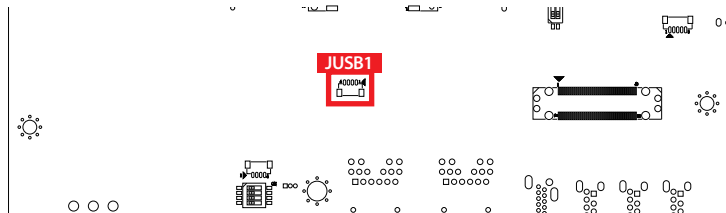

The USB Connector is reserve for GPS function. The USB Bus is switched by software control.

2.3.1.15 JUART : Debug UART for OOB

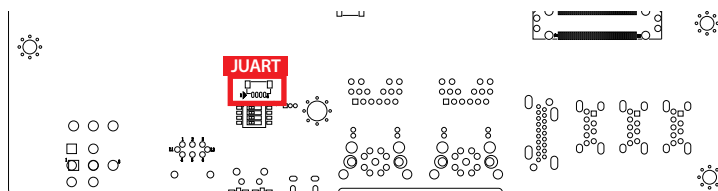

The connector is connected by OOB cable, it can transfer the debug UART signal to OOB, and it will monitor by Ethernet remote the system status. The UART Signal is switched by SW9.

2.4 Camera Board Expansion Connectors

2.4.1 B-to-B Connector

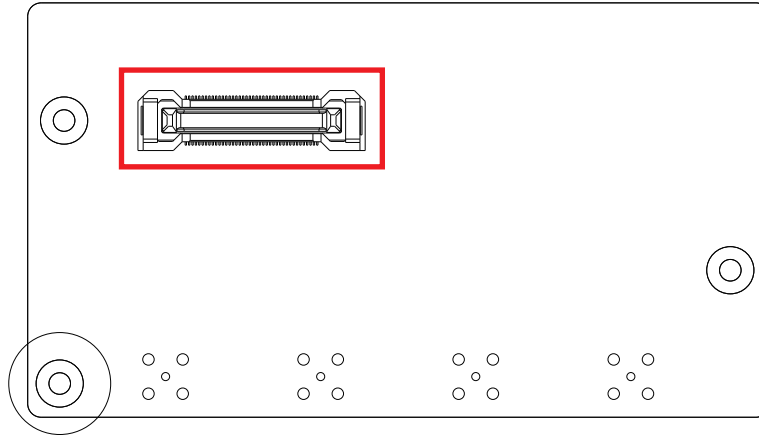

No.	Function	No.	Function	No.	Function	No.	Function
1	VCC12	21	CSI1_D0_P	41	GND	61	CSI0_CLK_N
2	VCC12	22	CSI1_D0_N	42	CAM1_MCLK	62	GND
3	VCC12	23	GND	43	CAM1_PWDN	63	CSI0_D0_P
4	VCC12	24	GND	44	GND	64	CSI0_D0_N
5	VCC12	25	GND	45	CSI2_D1_P	65	GND
6	VCC12	26	NC	46	CSI2_D1_N	66	NC
7	GND	27	NC	47	GND	67	NC
8	CSI3_D1_P	28	GND	48	CSI2_CLK_P	68	GND
9	CSI3_D1_N	29	VCC3	49	CSI2_CLK_N	69	NC
10	GND	30	VCC3	50	GND	70	NC
11	CSI3_D0_P	31	VCC3	51	CSI2_D0_P	71	GND
12	CSI3_D0_N	32	VCC3	52	CSI2_D0_N	72	NC
13	GND	33	VCC3	53	GND	73	NC
14	CAM_I2C_SCL	34	GND	54	CAM0_MCLK	74	GND
15	CAM_I2C_SDA	35	VCC5	55	CAM0_PWDN	75	NC
16	CAM_GPIO	36	VCC5	56	GND	76	GND
17	GND	37	VCC5	57	CSI0_D1_P	77	VCC5
18	CSI1_D1_P	38	VCC5	58	CSI0_D1_N	78	VCC5
19	CSI1_D1_N	39	VCC5	59	GND	79	VCC5
20	GND	40	VCC5	60	CSI0_CLK_P	80	VCC5

2.4.2 JMFP Header

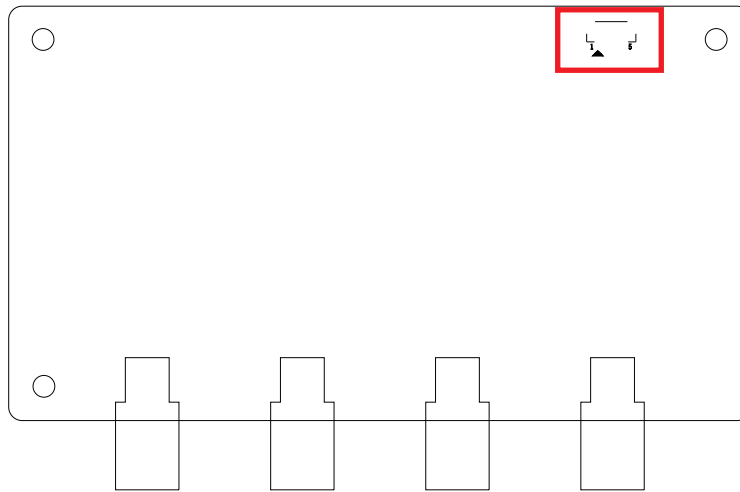

The JMFP Header is connected to the GMSL deserializer FSYNC input.

JMFP Header Pin Out:

Pin No.	Function
1	MFP6_IC1
2	MFP6_IC2
3	MFP_5V
4	MFP_5V
5	GND

2.5 Main Board Jumper / Switch Settings

2.5.1.1 Board Top View of EAC-6000 Main Board with Jumper.

The figure below is the top view of EAC-6000 series main board which is the main board. It shows the location of the jumpers.

Top Side

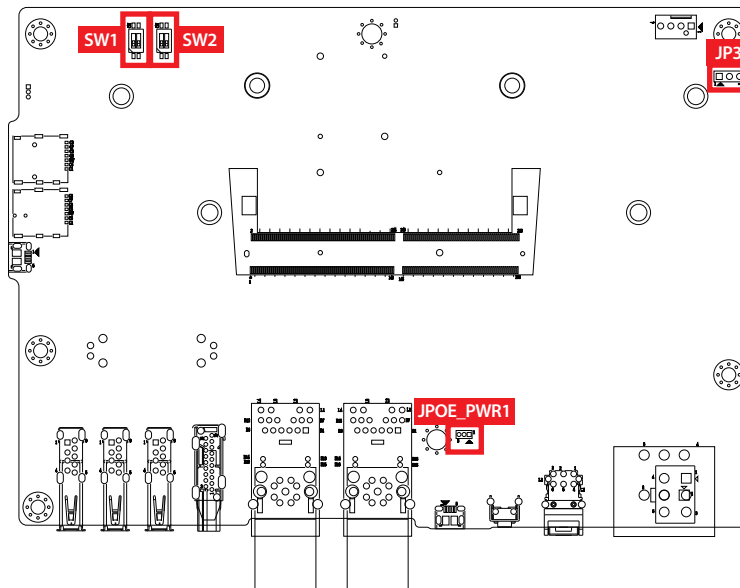

Bottom Side

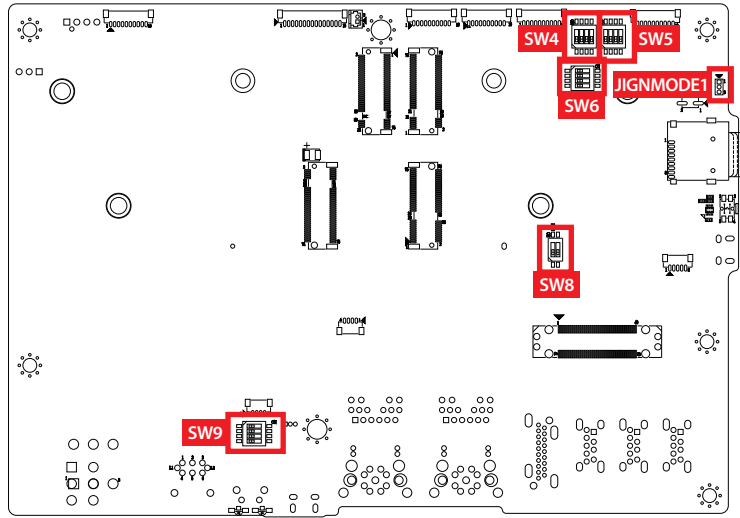

You may configure your card to match the needs of your application by setting jumpers. A jumper is a metal bridge used to close an electric circuit. It consists of two metal pins and a small metal clip (often protected by a plastic cover) that slides over the pins to connect them. To "close" a jumper, you connect the pins with the clip. To "open" a jumper, you remove the clip. Sometimes a jumper will have three pins, labeled 1, 2 and 3. In this case you would connect either pins 1 and 2, or 2 and 3.

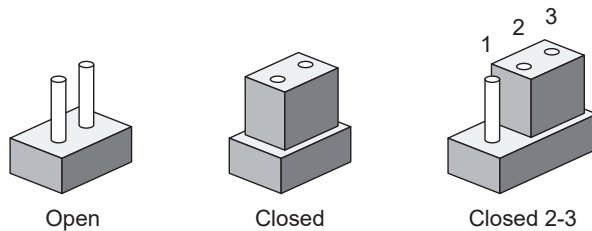

You may configure your card to match the needs of your application by DIP switch. As below show the DIP switch on and off.

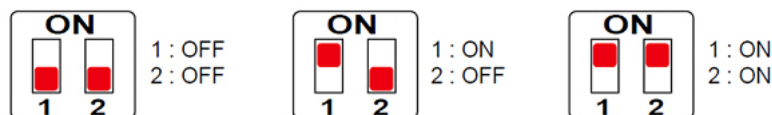

2.5.1.2 JP3 : SOM_FAN1 Operation Voltage Select

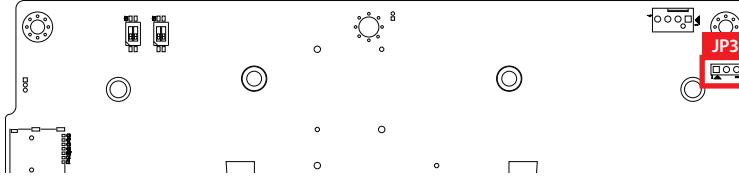

	Pin No.	Definition
	1	PWR 5V
	2	FAN1PWR
	3	PWR 12V

2.5.1.3 JPOE_PWR1: PoE Power On Select Mode

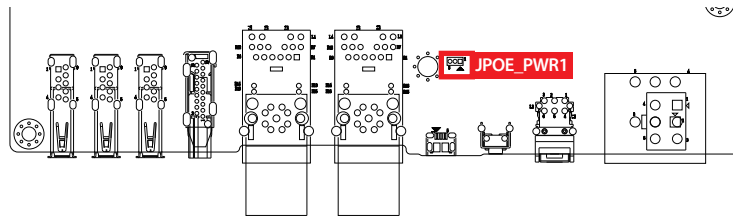

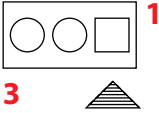
	Pin No.	Definition
	1	3V3ALW_PWRON
	2	3V3_PWRRUN
	3	VCC3_PWRON

2.5.1.4 SW5/SW4 : COM1/COM2 Port Mode Select

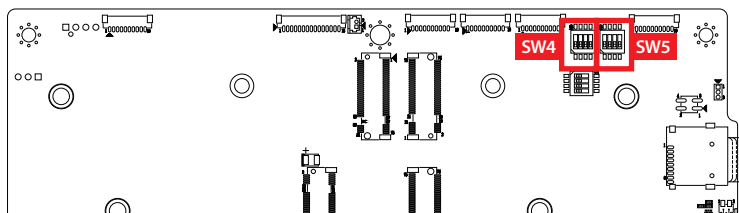

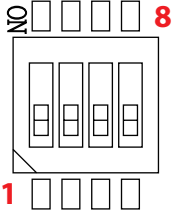
	Pin No.	Definition
	1	COM_MODE2
	2	COM_MODE1
	3	COM_MODE0
	4	SLEW
	5	COM_MODE2_H
	6	COM_MODE1_H
	7	COM_MODE0_H
	8	SLEW_H

The COM1 and COM2 Ports Mode have to be changed by SW4 & SW5 respectively. Please refer to below figure the truth table of mode.

Switch ON/OFF type status.

Switch to “ON”, the signal voltage level will be changed to “High”.

Switch to “OFF”, the signal voltage level will be changed to “Low”.

SLEW

0 -> RS-232 to 3 Mbps or RS-485/RS-422 to 20 Mbps

1 -> Logic low input will limit driver slew rate to 250Kbps for RS-232 and RS-485/RS-422

Mode_0	Mode_1	Mode_2	Mode	Status
0	0	1	Pure RS-232	3T/5R RS-232
0	1	1	ccTalk	ccTalk with SINN as Open Drain Output
1	0	1	RS-485 Half Duplex	<ul style="list-style-type: none"> • 1T/1R RS-485 • TX Enable Low Active with Auto Sensing (also mean AutoDirection Control) • Check Table 2 for choosing the related resistor
1	1	1	Full Duplex	<ul style="list-style-type: none"> • 1T/1R RS-422 • TX Enable Low Active with Auto Sensing (also mean Auto Direction Control) • Check Table 2 for choosing the related resistor

2.5.1.5 SW1/SW2 : COM1 /COM2 Terminal Enable/Disable

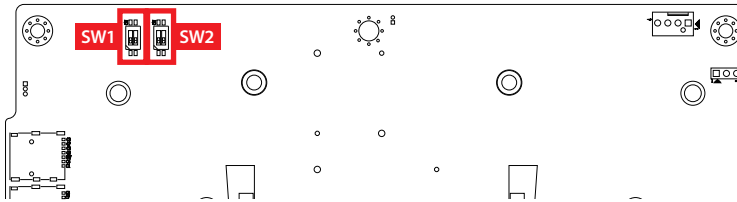

There are two types of Terminal Resistors Internal and External. It can refer below truth table to select resistor type when you want to do.

The Internal R is designed in IC when used for RS422 (TXD & DTR) / RS485 (DCD & RXD).

The External R is designed by outside adjustable R when used for RS422 (TXD & DTR / DCD & RXD) / RS485 (DCD & RXD).

2.5.1.6 JIGNMODE1 : Ignition Mode Select

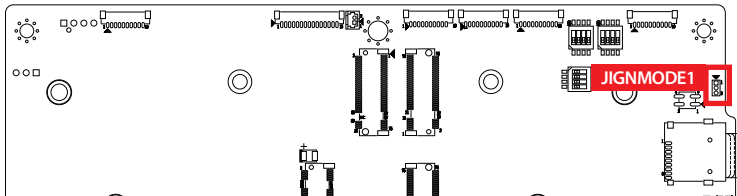

If the system use the ignition mode, the function can be changed by jumper setting. The default is H/W setting, it can be changed by software, but the jumper must be changed Pin 2-3 short.

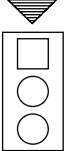
	Pin No.	Definition
	1-2	H/W MODE(Default)
	2-3	S/W MODE

2.5.1.7 SW8:UART / USB SELECT

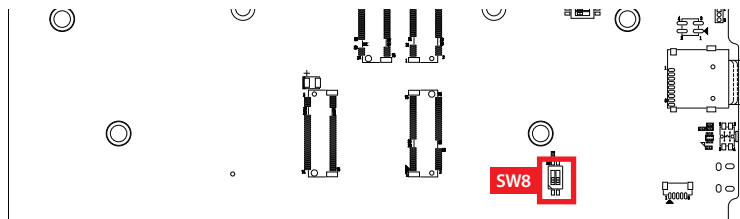

The DIP Switch can change what the function you want for SD card, Audio, UART and OOB function. The SD card and Audio only option 1 can be used. The UART and OOB only option 1. Please refer as below function Table.

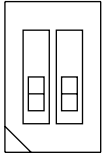
	Pin No.	Definition
	1	GND
	2	GND
	3	5V
	4	3.3V

On Channel	SW8.1
OOB	L
COM	H
On Channel	SW8.2
SD	L
AUDIO	H

****Please make sure the power off when you're changing the switch.****

2.5.1.8 SW9:Debug UART (OOB)

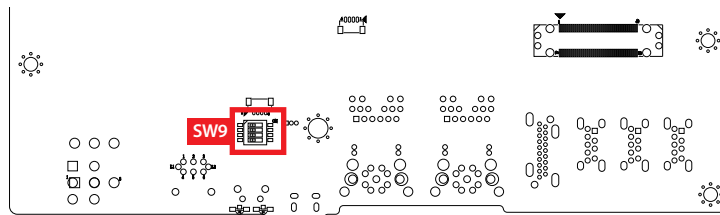

The debug UART is connected to console port (Micro USB), it can monitor what the system status is when the system is booted up. It also can be changed to OOB when use remote control by Ethernet.

	Pin No.	Definition	Status	
	1	RXD_FT	1 , 3 ON 2 , 4 OFF	M-USB CONSOLE
	2	RXD_FT	1 , 3 OFF 2 , 4 ON	OOB
	3	TXD_FT	-----	-----
	4	TXD_FT	-----	-----
	5	MICRO_B_RXD	-----	-----
	6	OOB-RXD	-----	-----
	7	MICRO_B_TXD	-----	-----
	8	OOB-TXD	-----	-----

2.6 Ignition Control

EAC-6000 series provides ignition power control feature for in-vehicle applications. The built-in MCU monitors the ignition signal and turns on/off the system according to pre-defined on/off delay period

2.6.1 Adjust Ignition Control Modes

EAC-6000 series provides 16 modes of different power on/off delay periods adjustable via SW6 switch. The default DIP switch is set to 0 in ATX power mode.

SW6 : Ignition Control

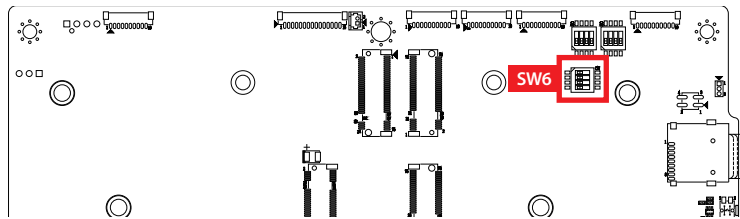

The modes are listed in below table :

DIP Switch Position	Power on delay	Power off delay	Switch Position
0	ATX mode		
1	No delay	10 seconds	
2	No delay	15 seconds	
3	No delay	20 seconds	
4	No delay	30 seconds	
5	No delay	60 seconds	
6	5 seconds	10 seconds	
7	5 seconds	30 seconds	
8	5 seconds	60 seconds	

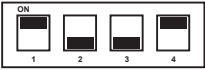
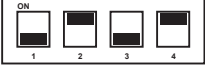
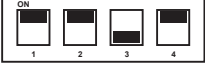
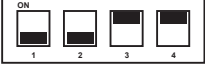
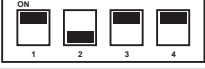
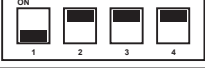
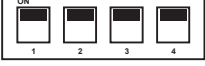
9	5 seconds	90 seconds	
A	5 seconds	120 seconds	
B	10 seconds	10 seconds	
C	10 seconds	30 seconds	
D	10 seconds	60 seconds	
E	10 seconds	90 seconds	
F	AT Mode		

2.6.2 Ignition Control Wiring

To activate ignition control, you need to provide IGN signal via the 3-pin pluggable terminal block locates in the back panel. Please find below the general wiring configuration.

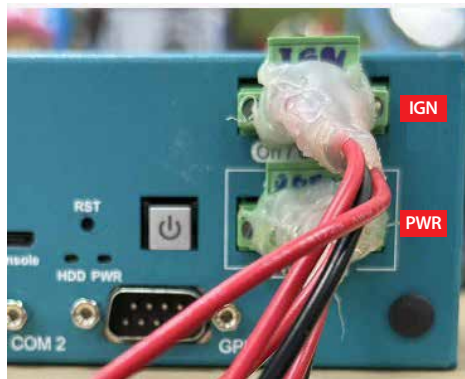

For testing purpose, you can refer to the picture blow to simulate ignition signal input controlled by a latching switch.

3

SYSTEM SETUP

3.1 How to Open Your EAC-6000/EAC-6100/EAC-6200

Step 1 Remove four F-M3x4L screws.

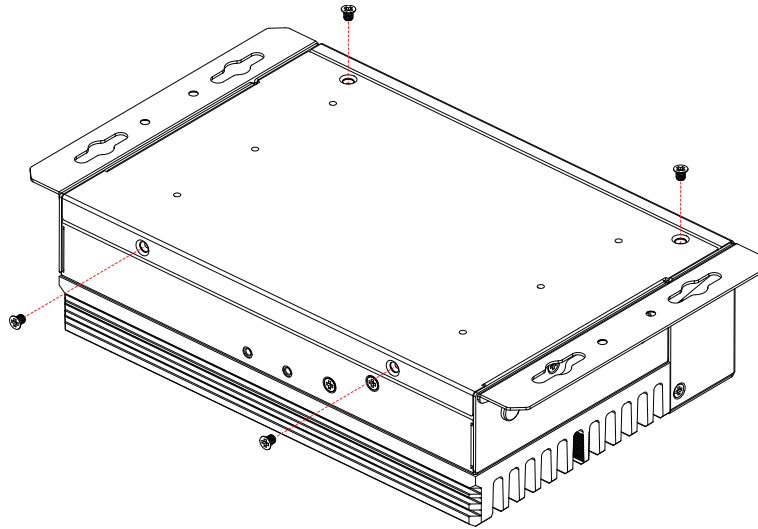

Step 2 Pick up bottom cover.

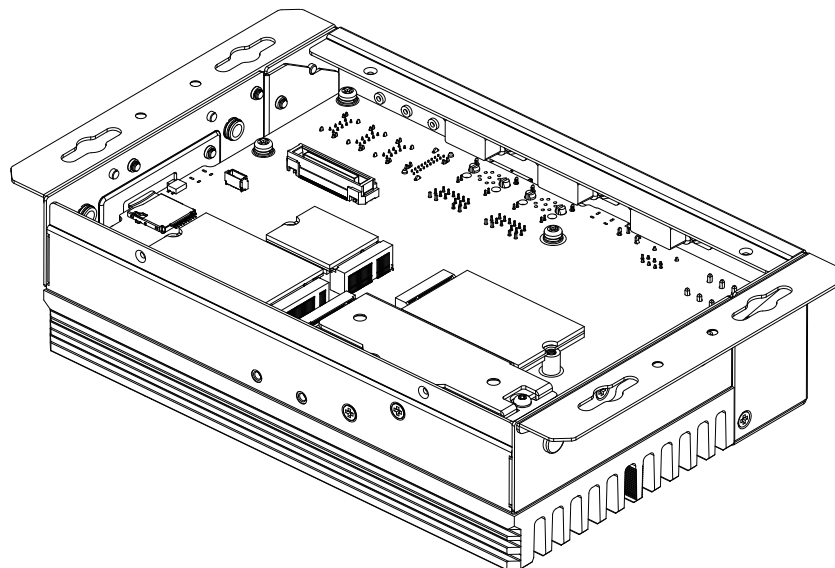

3.2 Installing Nano SIM Card

Step 1 Remove two F-M3x4L screw on SD/SIM cover.

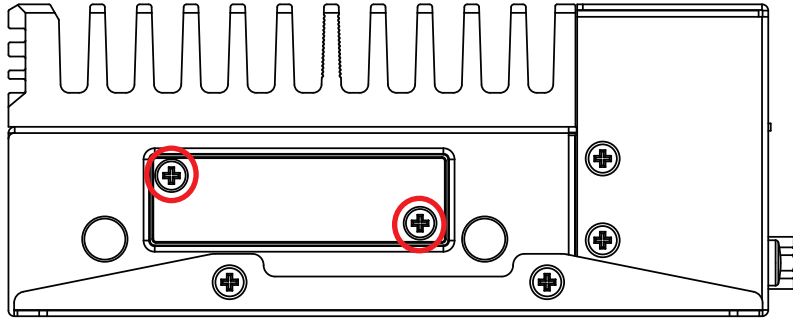

Step 2 Inserting SIM card, make sure the system power is not plugged.

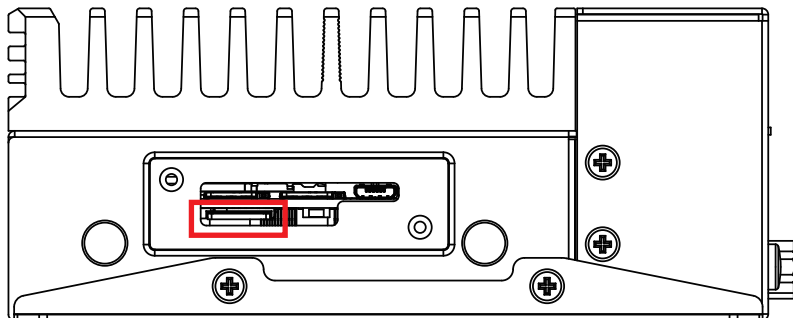

3.3 Installing Micro SD Card

Step 1 Remove one F-M3x4L screw on SD/SIM cover.

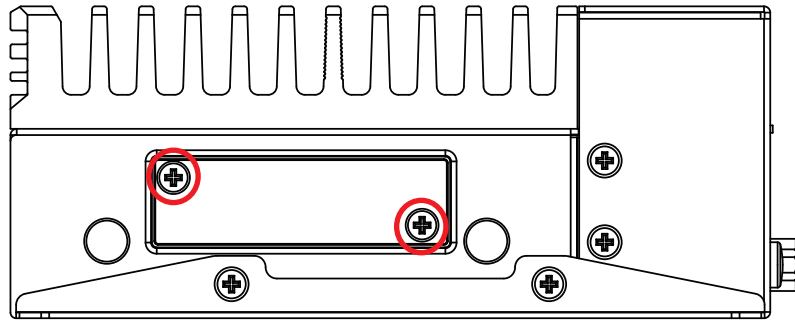

Step 2 Inserting SD card.

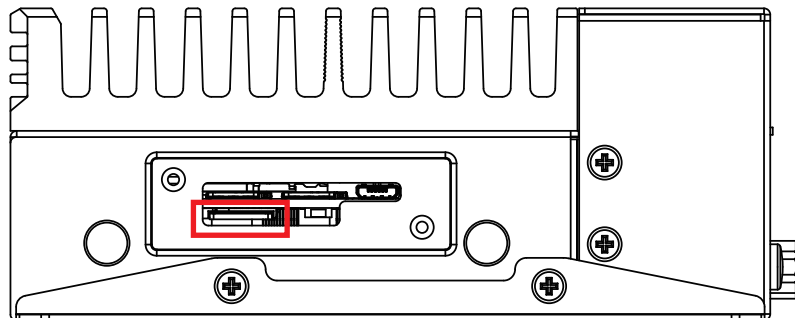

3.4 Installing M.2

3.4.1 M.2 Key E 2230

Step 1 Install M.2 Key E 2230 into slot and fasten one pan head M3x4L screw.

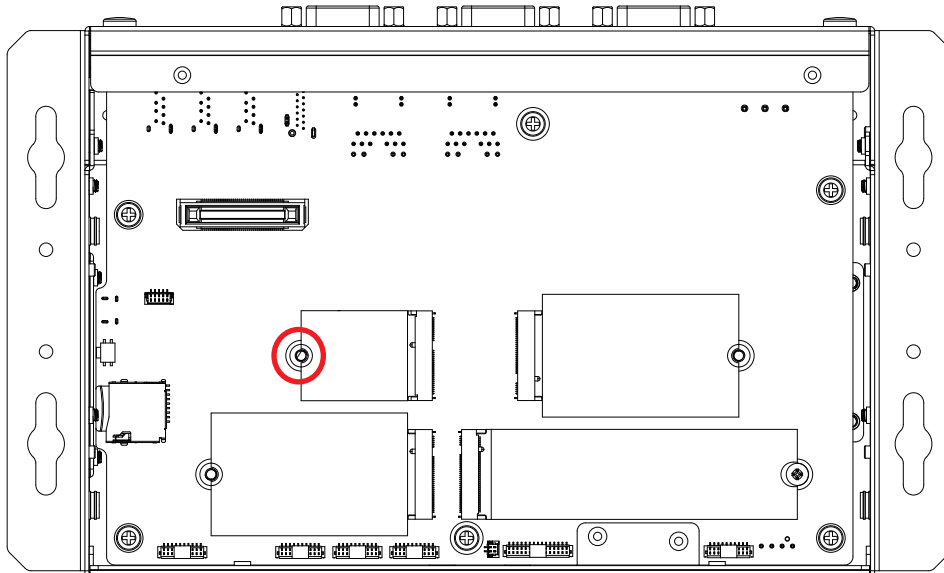

3.4.2 M.2 Key M 2280

Step 1 Install M.2 Key M 2280 into slot.

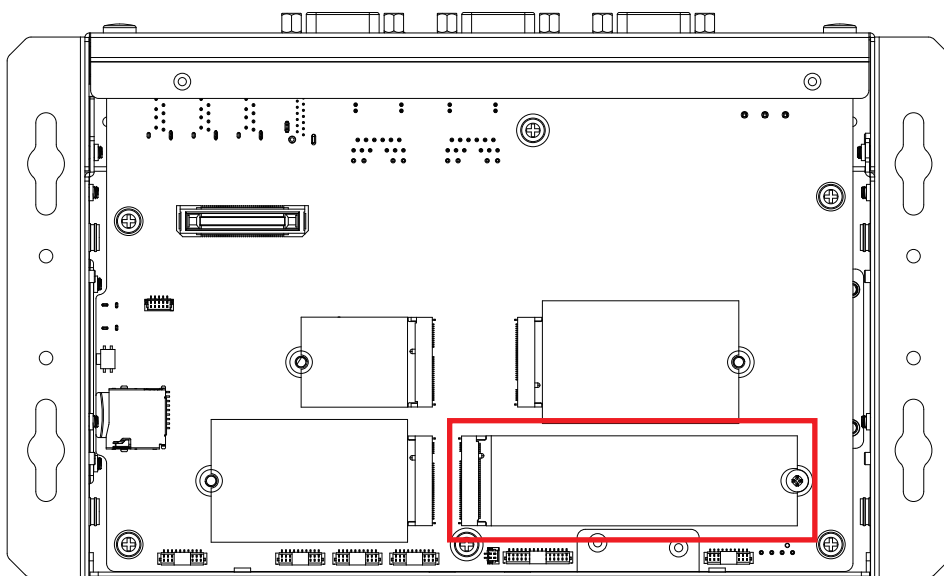

Step 2 Install M.2 Key M cover into slot.

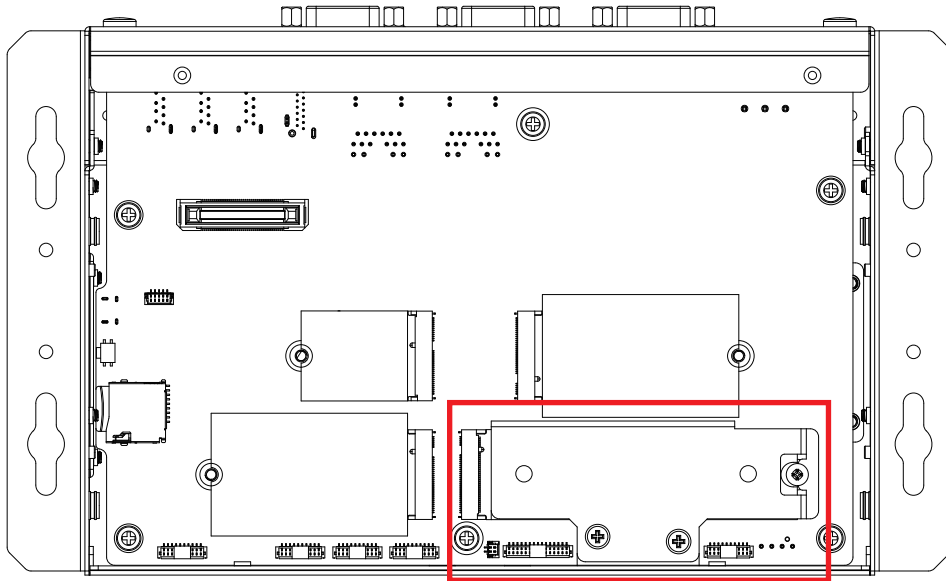

Step 3 Fasten one pan head M3x4L screw and two F-M3x4L screw.

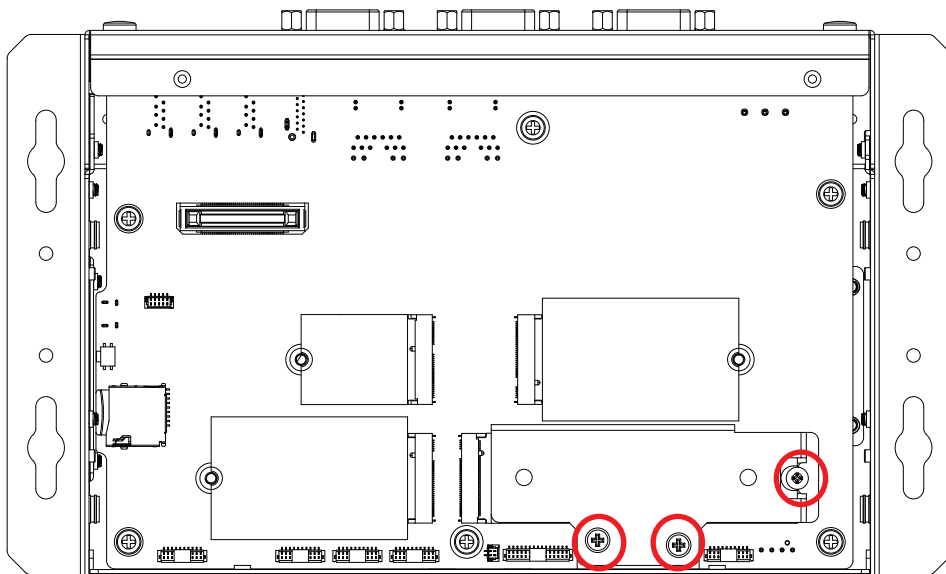

3.4.3 M.2 Key B 3042

Step 1 Install transfer bracket into nut and fasten one pan head M3x4L screw.

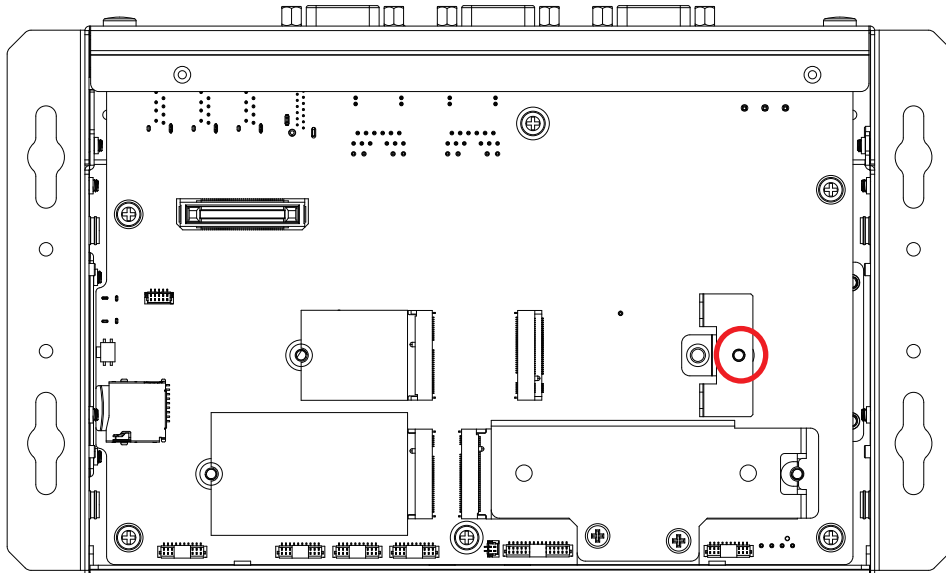

Step 2 Install M.2 Key B 3042 into slot and fasten one pan head M3x4L screw.

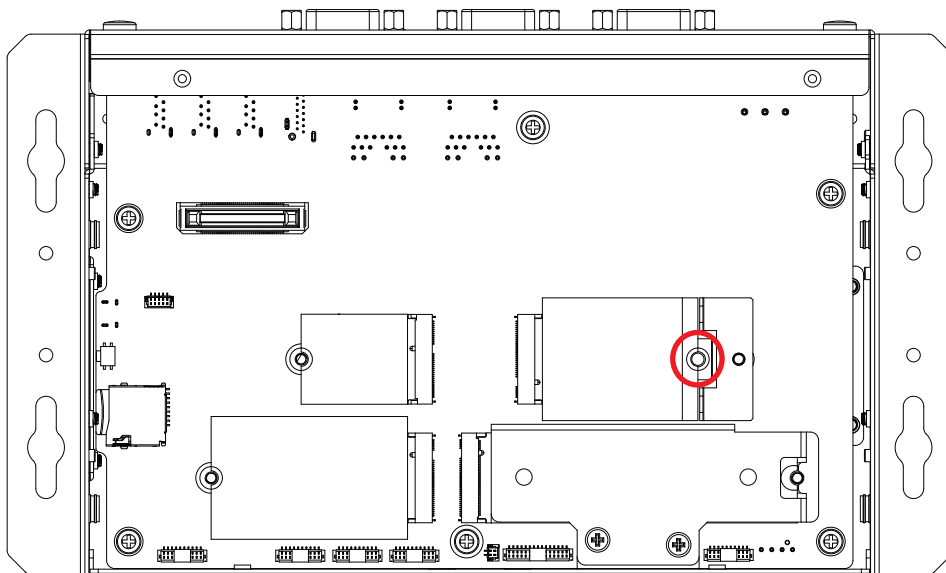

3.4.4 M.2 Key B 3052

Step 1 Fasten one pan head M3x4L screw.

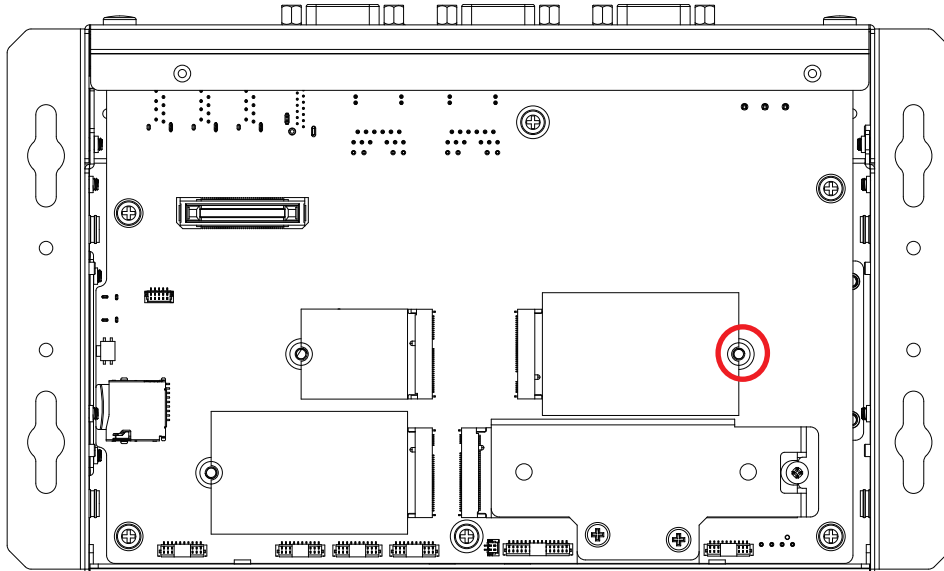

3.5 Installing Antenna Cable

Step 1 Remove the rubber corks on the panel.

Step 2 Install the cable with nut and washer indicated.

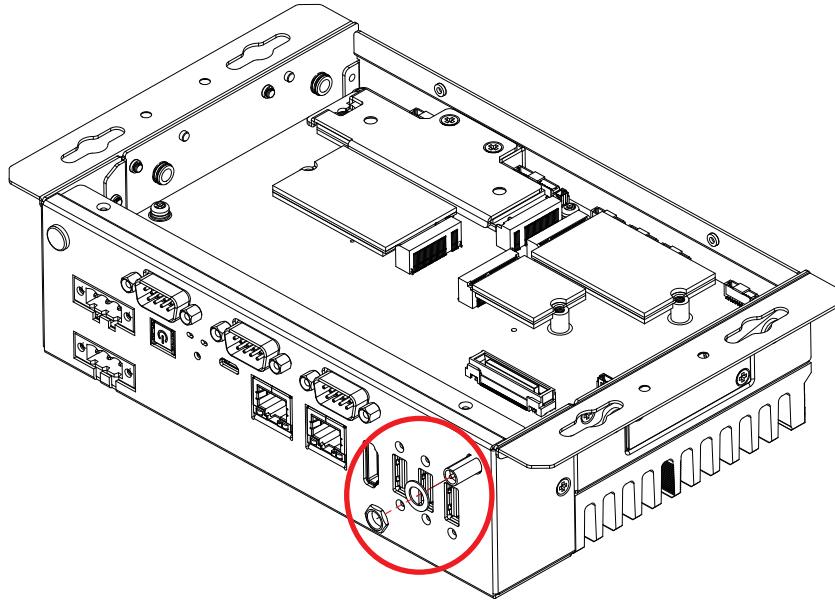

3.6 Mounting Your EAC-6000/EAC-6100/EAC-6200

3.6.1 Wall Mount

Install wall mount bracket then fasten four pcs F-M3x4L screw.

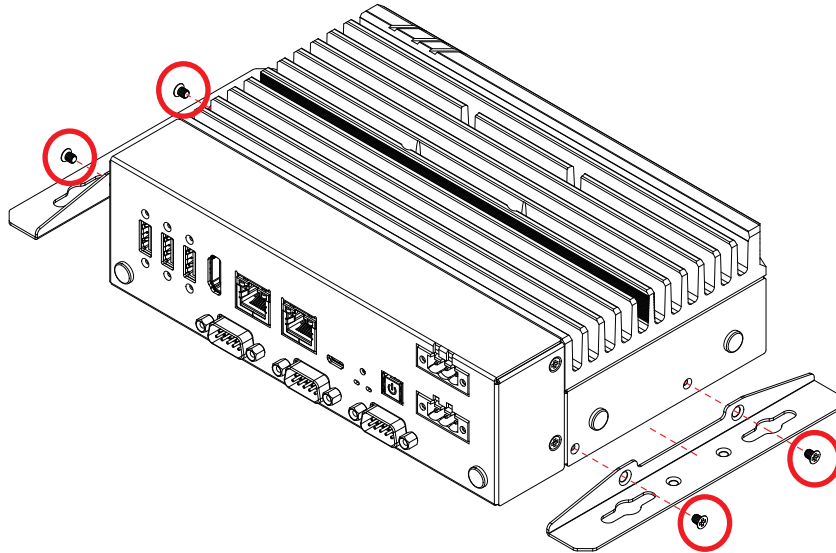

3.6.2 DIN Rail Mount

Install din rail kit then fasten two pcs F-M3x4L screw.

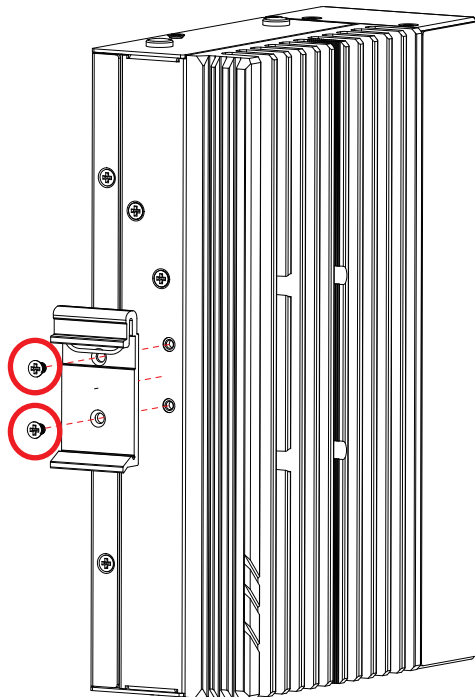

4

SOFTWARE SETUP

4.1 Peripheral Interface Guide

For I/O support and example please find the folder "EAC-6000_Sample_API" on the desktop.

4.2 Flash image to Your EAC-6000/6100/6200

Before starting the flashing process, be sure the **EAC-6000** is turned off and disconnected from the power. You also need to prepare a **host computer** running with Ubuntu 18.04 or later.

4.2.1 Prepare the host computer

Step 1: Open a terminal on host computer and disable the automount of new external storage devices temporarily. On most distributions of Debian-based Linux, you can do this using the following command:

```
$ systemctl stop udisks2.service
```

Step 2: Run the following script to ensure that the host computer has the "nfs-kernel-server" service running:

```
$ sudo service nfs-kernel-server start
```

4.2.2 Download the OS image file to the host computer

Step 1: Download the OS image package file. The file name will be similar to:

```
mfi_p3768-0000+p3767-0000_*GB.tbz2
```

Step 2: Check the MD5 Checksum by the following command:

```
$ sudo md5sum -c ./mfi_p3768-0000+p3767-0000_*GB.tbz2.md5
```

Step 3: Open a Linux terminal on host computer and issue the following command to extract compressed image files:

```
$ sudo tar xvf mfi_p3768-0000+p3767-0000_*GB.tbz2
```

Step 4: Run the following script to install the right dependencies from the decompressed folder:

```
$ sudo ./l4t_flash_prerequisites.sh
```

4.2.3 Connect EAC-6000 to the host computer

Step 1: Connect the power adapter to the EAC-6000, The EAC-6000 is not yet turned on at this time.

Step 2: Connect the Micro USB cable to the “Flash” Port on EAC-6000 and the other end to an available USB port on the host computer. You can connect up to five EAC-6000 devices in recovery mode plugged in the host.

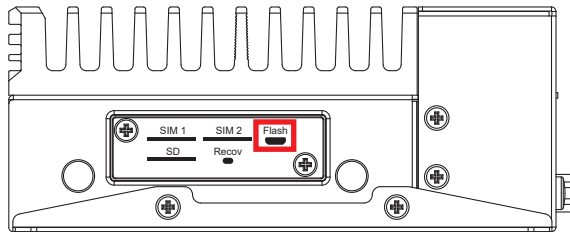

Step 3: Press and hold the “Recov” button.

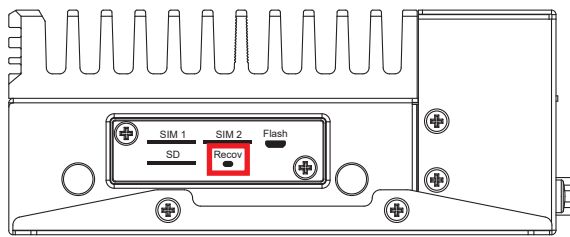

Step 4: Keep holding the “Recov” button, and power on the EAC-6000. Continue to hold the “Recov” button at least two seconds, and release.

Step 5: Now that the device is in recovery mode, issue “lsusb” command on host PC to find a new USB device like:

```
BUS 003 Device 005: ID 0955:7e19 Nvidia Corp.
```

4.2.4 Flash image to the EAC-6000

Step 1: Open a terminal on host PC, then access the package folder you extracted in step 2-3.

Step 2: Run this command from the decompressed folder to flash the image, this will take a while:

```
$ sudo ./EAC-6000_flash.sh
```

4.3 Install the JetPack Package

To install the JetPack package on EAC-6000, you can issue the following commands:

```
$ sudo apt update
```

```
$ sudo apt install nvidia-jetpack
```

4.4 Software Ignition Control

Vecow provides Ignition Software to control power on/off delay periods.

To activate software ignition control, you need to adjust the **JIGNMODE1** jumper to 2-3,

You can access the following path to find the tool and instruction:

```
$ cd /usr/src/tools/EAC-6000/ignition/
```

A

APPENDIX A : Power Consumption

Testing Board	EAC-6000
RAM	16 GB 128-bit LPDDR5
USB-1	USB Microsoft Wired Keyboard 600
USB-2	USB Mouse HP G1K28AA
USB-3	USB Flash Kingston 3.0 16GB
USB-4	USB Flash Kingston 3.0 16GB
USB-5	USB Flash Kingston 3.0 16GB
SD	SD card
Storage	M.2 Key M
M.2 KEY E	Intel AX210NGW
LAN 1	1.0 Gbps
LAN 2	1.0 Gbps
Graphics Output	HDMI
Power Plan	MAXN(16GB, 8GB)
Power Source	Chroma 62006P-100-25
Test Program	Burn-in Test, Stress-ng Test

A.1 8-core Arm® Cortex®-A78AE v8.2 64-bit CPU, up to 2 GHz 1024-core NVIDIA Ampere™ GPU with 32 Tensor Cores (16GB)

Power on and boot to Ubuntu 20.04 LTS 64bit

CPU	Power Input	Ubuntu 20.04 LTS 64bit			
		idle status CPU usage less 3%		Run 100% CPU usage	
		Max Current	Max Consumption	Max Current	Max Consumption
8-core Arm® Cortex®-A78AE v8.2 64-bit CPU, up to 2 GHz	9V	1.613A	14.52W	2.659A	23.93W
	12V	1.243A	14.91W	1.964A	23.57W
	24V	0.678A	16.28W	1.042A	25.00W
	36V	0.495A	17.83W	0.732A	26.37W
	50V	0.427A	21.35W	0.603A	30.15W

A.2 8-core Arm® Cortex®-A78AE v8.2 64-bit CPU, up to 2 GHz 1024-core NVIDIA Ampere™ GPU with 32 Tensor Cores (8GB)

Power on and boot to Ubuntu 20.04 LTS 64bit

CPU	Power Input	Ubuntu 20.04 LTS 64bit			
		idle status CPU usage less 3%		Run 100% CPU usage	
		Max Current	Max Consumption	Max Current	Max Consumption
8-core Arm® Cortex®-A78AE v8.2 64-bit CPU, up to 2 GHz	9V	1.588A	14.29W	2.049A	18.44W
	12V	1.168A	14.02W	1.542A	18.50W
	24V	0.663A	15.92W	0.867A	20.82W
	36V	0.488A	17.55W	0.624A	22.46W
	50V	0.429A	21.43W	0.511A	25.55W

B

APPENDIX B : Supported Module List

B.1 Supported 5G/4G/GPS List

Type	Model	Support Standard
M.2 KEY B	Quectel EM06-E	LTE Category 6 Worldwide LTE-A and UMTS/HSPA+ Coverage GPS/GLONASS/BeiDou (Compass)/Galileo/ QZSS (Optional)
M.2 KEY B	Quectel RM500Q-AE	5G sub-6GHz Worldwide 5G and LTE-A coverage GPS/GLONASS/BeiDou (Compass)/Galileo
M.2 KEY B	CINTERION Thales_ MV31-W	5G sub-6GHz Global 5G coverage and LTE Cat. 20 fallback GPS, Glonass, Beidou and Galileo

B.2 Supported Wi-Fi/Bluetooth List

Type	Model	Support Standard
M.2 KEY E	SparkLAN_WNFT- 237ACN(BT)	IEEE 802.11ac/a/b/g/n BT5.0
M.2 KEY E	jjPlus JWW6051	IEEE 802.11ac/a/b/g/n BT5.0
M.2 KEY E	Intel AX210NGW	IEEE 802.11a/b/e/g/h/i/k/n/r/u/v/w/ac/ax BT5.3



For further support information, please visit www.vecow.com

This document is released for reference purpose only.

All product offerings and specifications are subject to change without prior notice.

No part of this publication may be reproduced in any form or by any means, electric, photocopying, or recording, without prior authorization from the publisher.

The rights of all the brand names, product names, and trademarks belong to their respective owners.

© Vecow Co., Ltd. 2024. All rights reserved.